

K565

v.01



A x 04	B x 02	C x 02	D x 20	E x 26	F x 26	G x 36	H x 16	I x 08
J x 02	K x 08	L x 04	M x 02	N x 10	Ñ x 02	O x 02	P x 06	Q x 04
R x 01	S x 14	T x 06	U x 04					

5,8 mm, 5,5 x 60 mm, 3.5 x 15 mm., 3.5 x 20 mm., 4 x 27 mm., 8 mm., Nº 4, 15 mm., 7 mm., 2/2

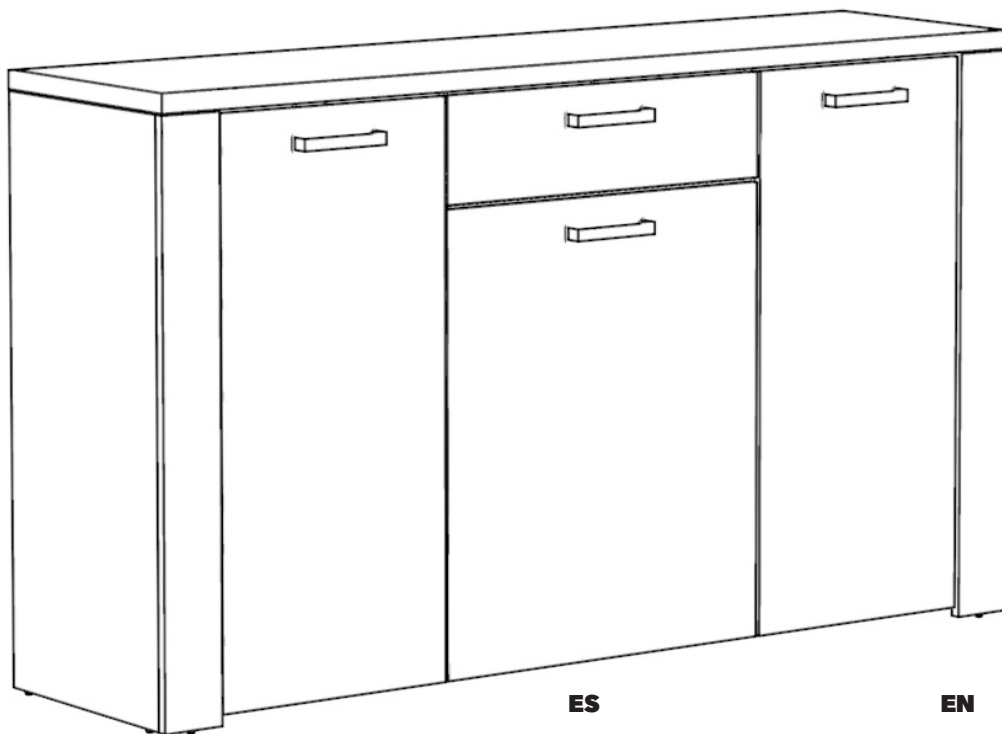

ES

RECOMENDACIONES MONTAJE Y USO

Agrupe y cuente el herraje.
Prepare todas las piezas para el montaje del mueble.
Tenga preparadas las herramientas para el montaje.
Prepare la zona del montaje.
Monte el mueble sobre una moqueta para evitar rayar y dañar la superficie del mueble.
No fuerce los ensamblajes.
Evite colocar el mueble cerca de fuentes de calor.
Evite utilizar trapos, paños o productos de limpieza que puedan dañar la superficie del mueble.
Mueble para uso doméstico en interior de vivienda.

EN

RECOMMENDATIONS FOR ASSEMBLY AND USE

Prepare all the parts of the furniture
Group and count all the hardware
Prepare all the tools for the assembly.
Clear and prepare the assembly area.
Do the assembly on a carpet to avoid damaging the surface of the furniture
Avoid forcing the fittings
Avoid placing the Furniture near any heating source
Do not use cloths or cleaning products to avoid damaging the surface of the furniture
Indoor furniture. Suitable for domestic use.

FR

CONSEILS DE MONTAGE CONSEILS POUR L'USAGE

Préparez les différents parts du meuble
Regrouper et compter toute la quincaillerie
Préparez l'outillage nécessaire
Aménagez-vous une area de montage
Faire le montage sur moquette afin de protéger le meuble des rayures
Ne forcer pas le montage
Evitez placer le meuble près des sources de chaleur
Evitez utiliser de chiffons ou des produits de nettoyage pour ne pas rayer la superficie du meuble
Meuble d'usage domestique pour l'intérieur de la maison.

PT

RECOMENDAÇÕES PARA MONTAGEM E USO

Prepare todas as peças para a montagem de móveis
Reagrupar e contar o hardware
Preparar as ferramentas de montagem
Preparar a área de montagem
Montar as peças em um tapete para evitar riscos e danos na superfície dos móveis
Não force as assembleias
Não colocar móveis perto de fontes de calor
Evitar o uso de panos, trapos ou produtos de limpeza que possam riscar o móvel.
Móveis para uso doméstico no interior da casa.

IT

CONSIGLI INSTALLAZIONE ED USO

Preparare tutti componenti del mobile per il montaggio
Ordinare la ferramenta
Preparare tutti gli attrezzi necessari per il montaggio
Preparare l'area di montaggio
Fare il montaggio su un tappeto per evitare danneggiare le superfici dei mobili
Non forzare i componenti
Evitare posizionare il mobile in prossimità di fonti di calore
Non usare panni né detersivi né solventi che possano danneggiare le superficie dei mobili
Mobili per uso domestico all'interno della casa.

DE

MONTAGEHINWEISE-GEBRAUCHSHINWEISE

Identifizieren Sie die Einzelteile
Überprüfen Sie Die Anzahl der einzelnen Beschlagteile
Legen Sie das notwendige Werkzeug bereit
Bereiten die Montagefläche
Montieren Sie das Möbel auf einem Teppich, sauberen Untergrund
Niemaals die verbindungen zu start anziehen
Nicht neben Wärmequellen platzieren
Vermeiden Sie Tücher und keinesfalls scharfe oder ätzende Reinigungsmittel.
Möbel für den Gebrauch im Haus geeignet.

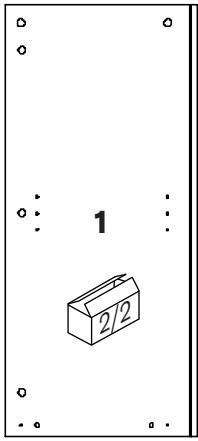

379 x 847 mm.

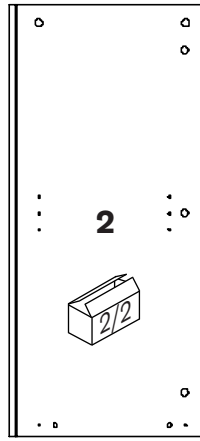

379 x 847 mm.

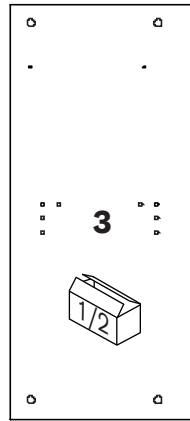

361 x 816 mm.

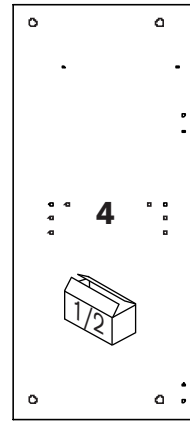

361 x 816 mm.

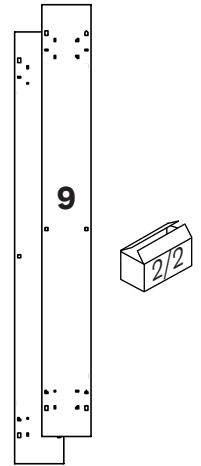

847 x 96 mm.

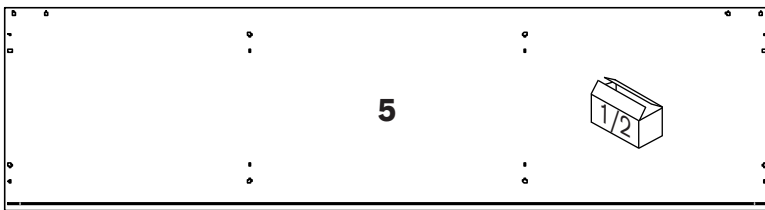

1500 x 400 mm.

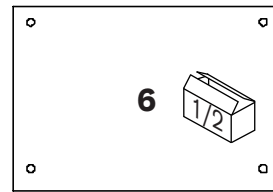

525 x 360 mm.

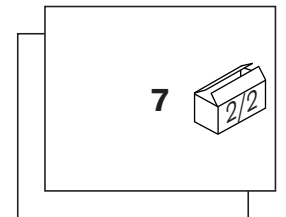

454 x 361 mm.

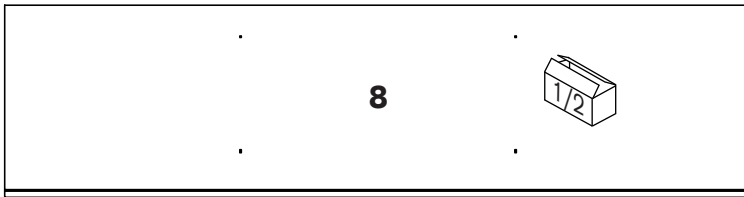

1466 x 379 mm.

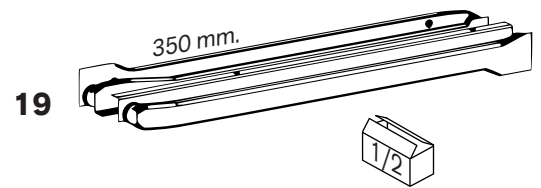

19

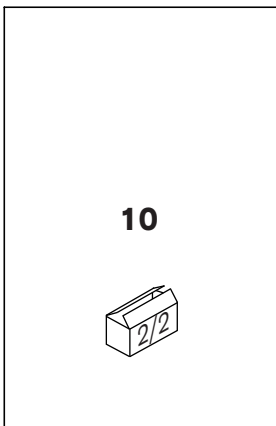

826 x 542 mm.

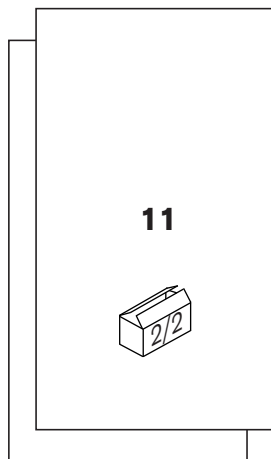

826 x 466 mm.

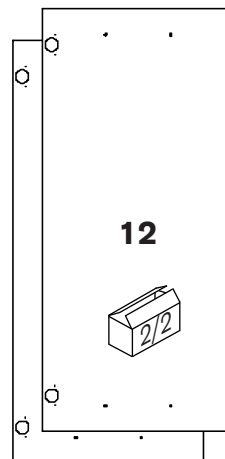

829 x 374 mm.

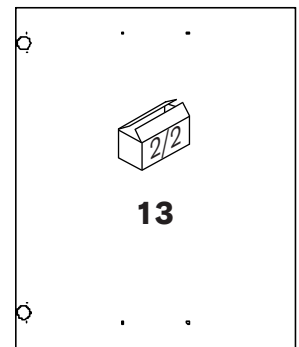

551 x 669 mm.

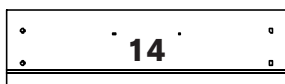

551 x 157 mm.

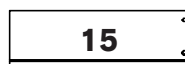

350 x 110 mm.



350 x 110 mm.



476 x 110 mm.

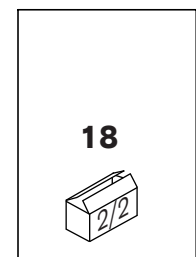

489 x 349 mm.



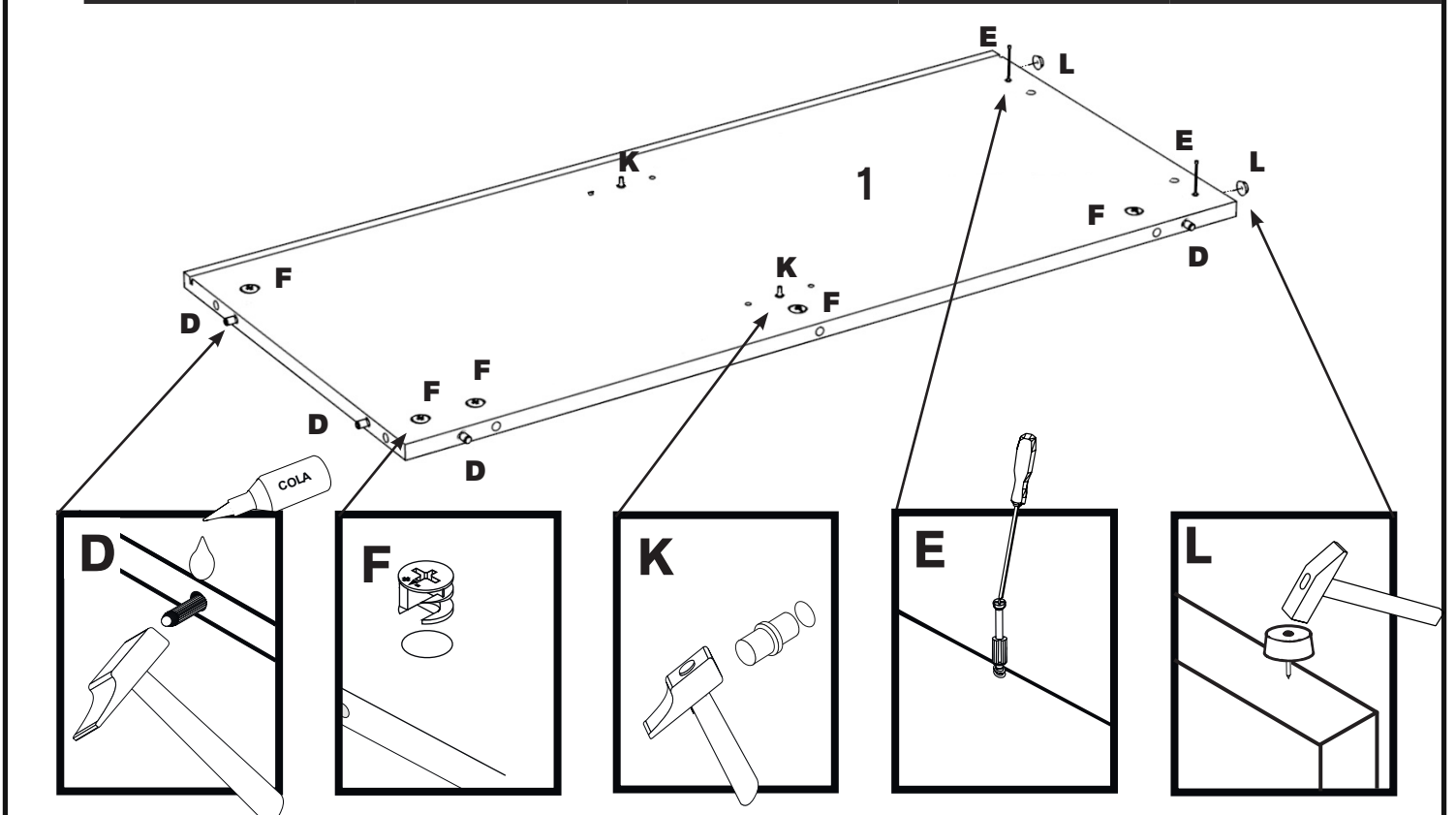
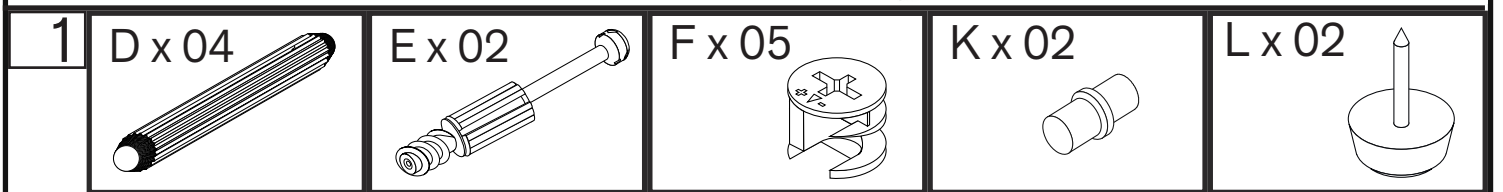
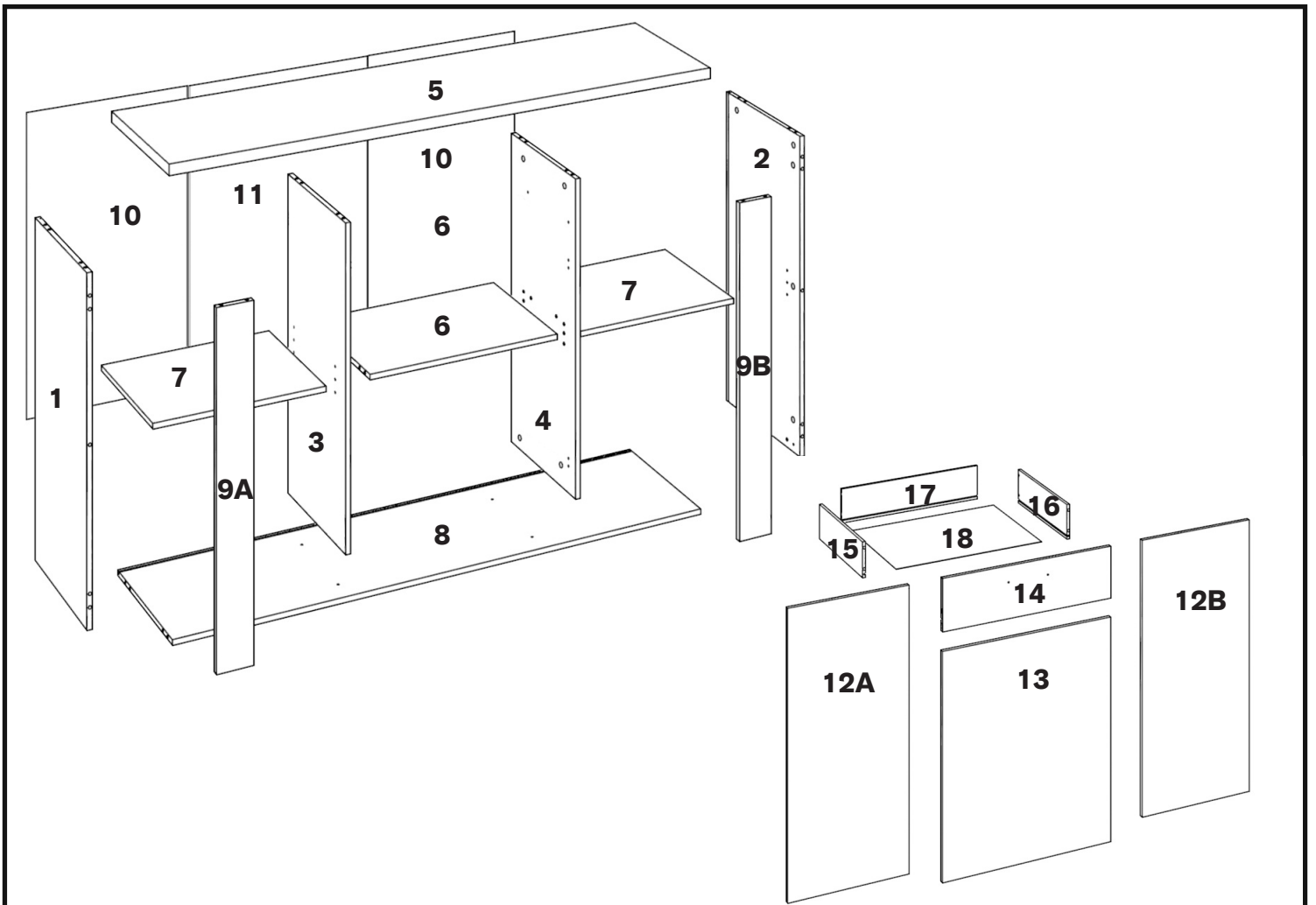

2

D x 04

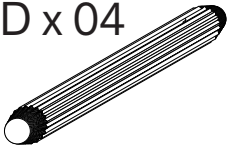

E x 02

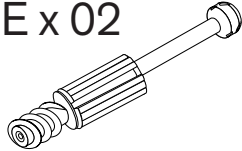

F x 05

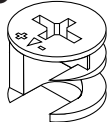

K x 02

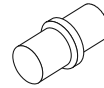

L x 02

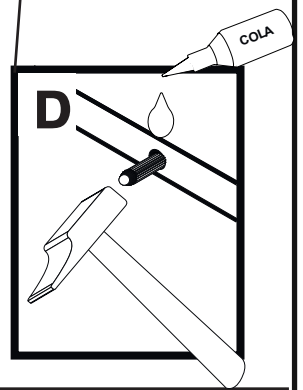
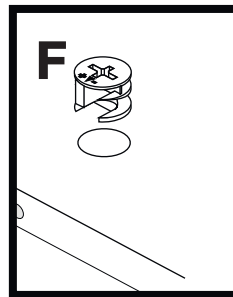
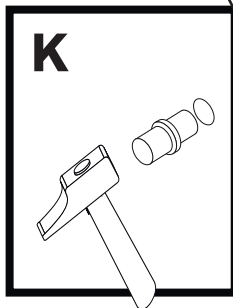
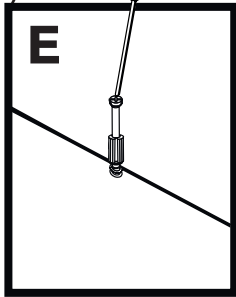
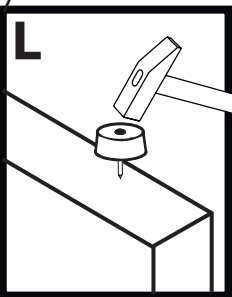
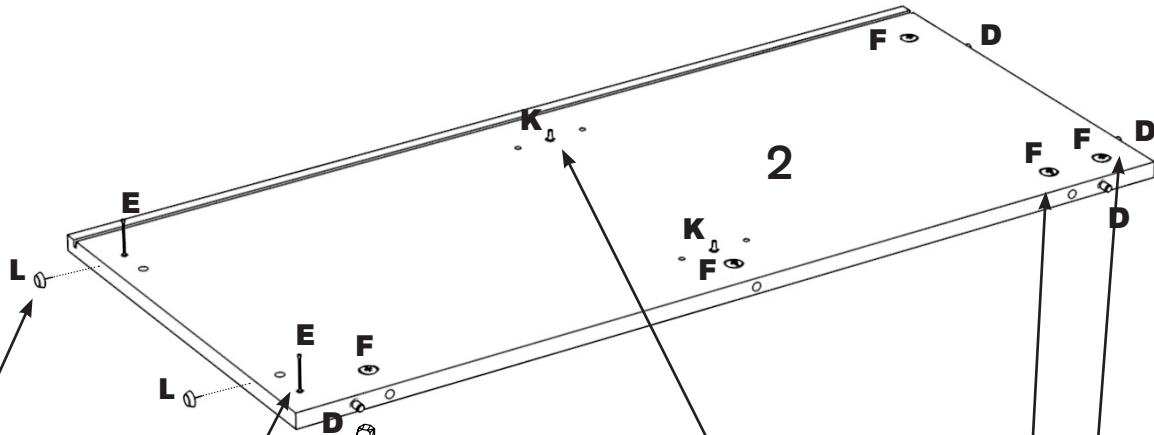
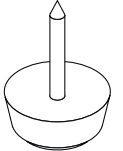

3

D x 02

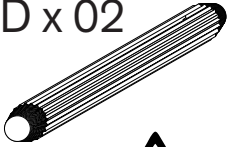

E x 02

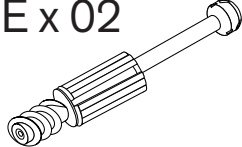

F x 04

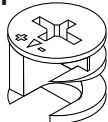

G x 02

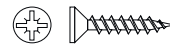

3.5 x 15 mm.

K x 02

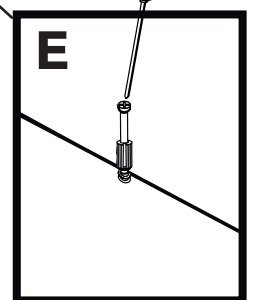
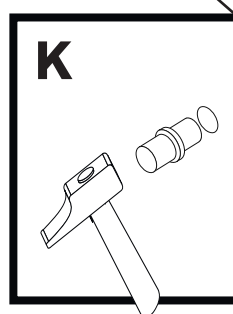
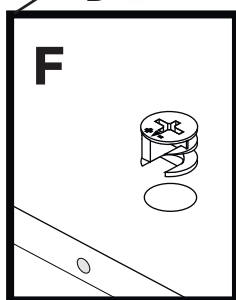
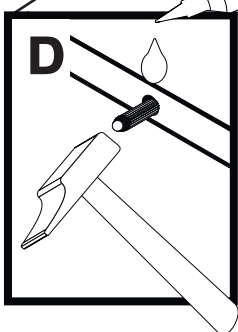
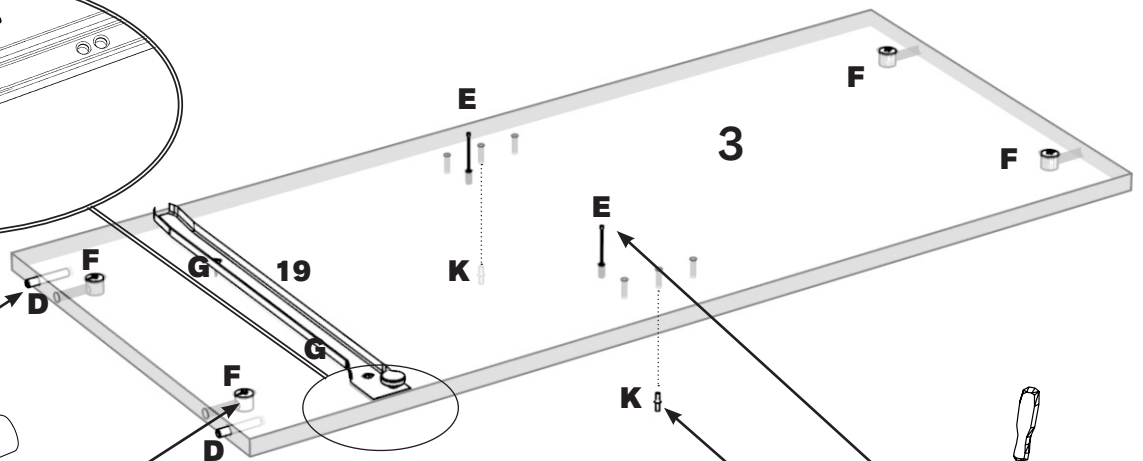
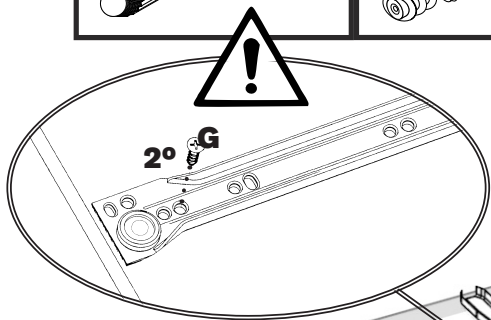
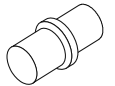

4

B x 02

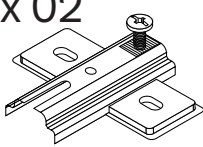

D x 02

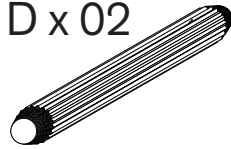

E x 02

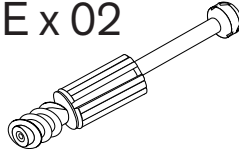

F x 04

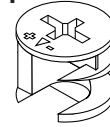

G x 06



3.5 x 15 mm.

K x 02

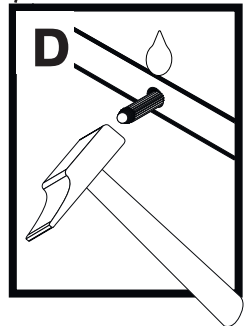
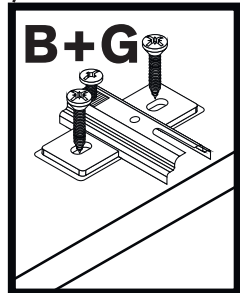
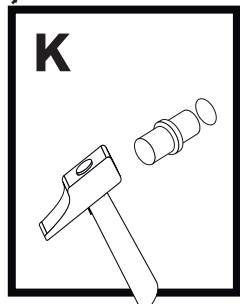
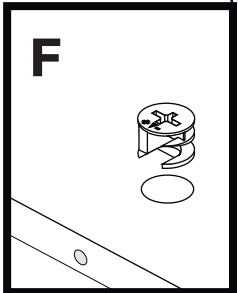
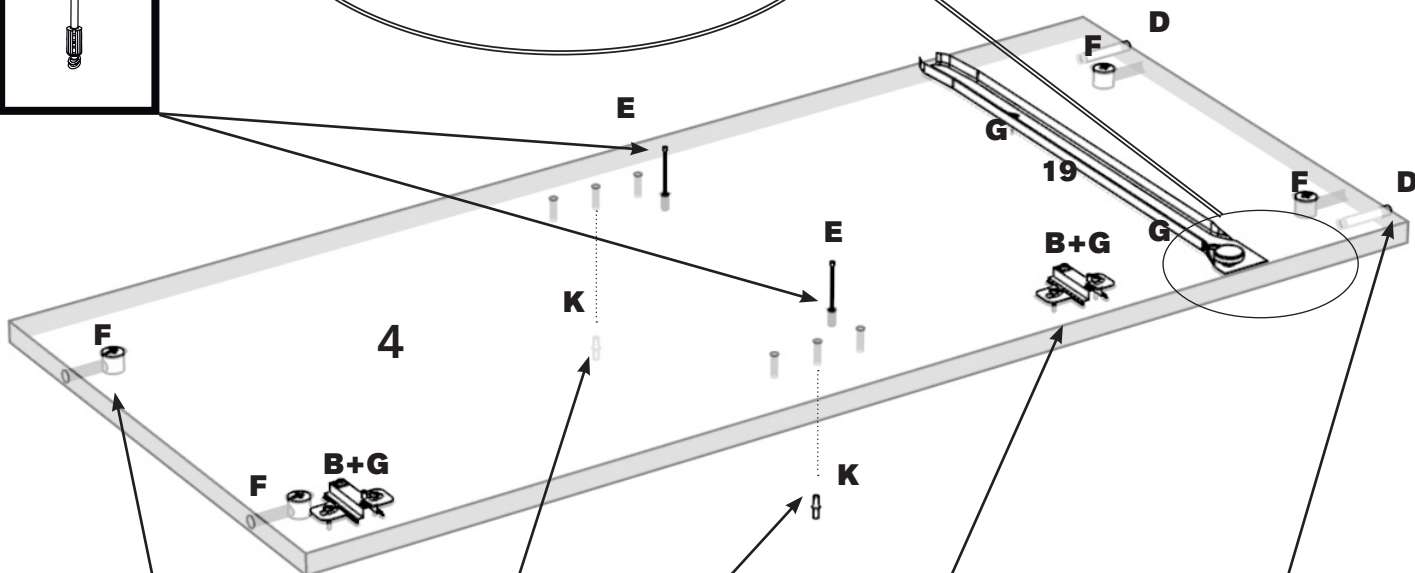
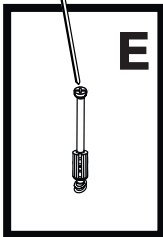
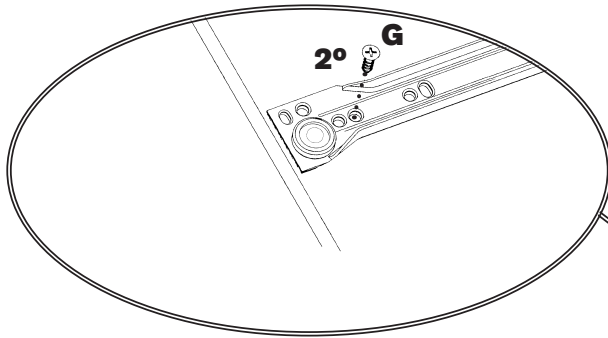
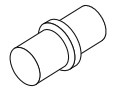

5 E x 08

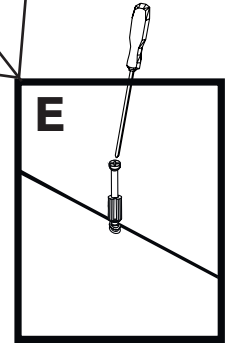
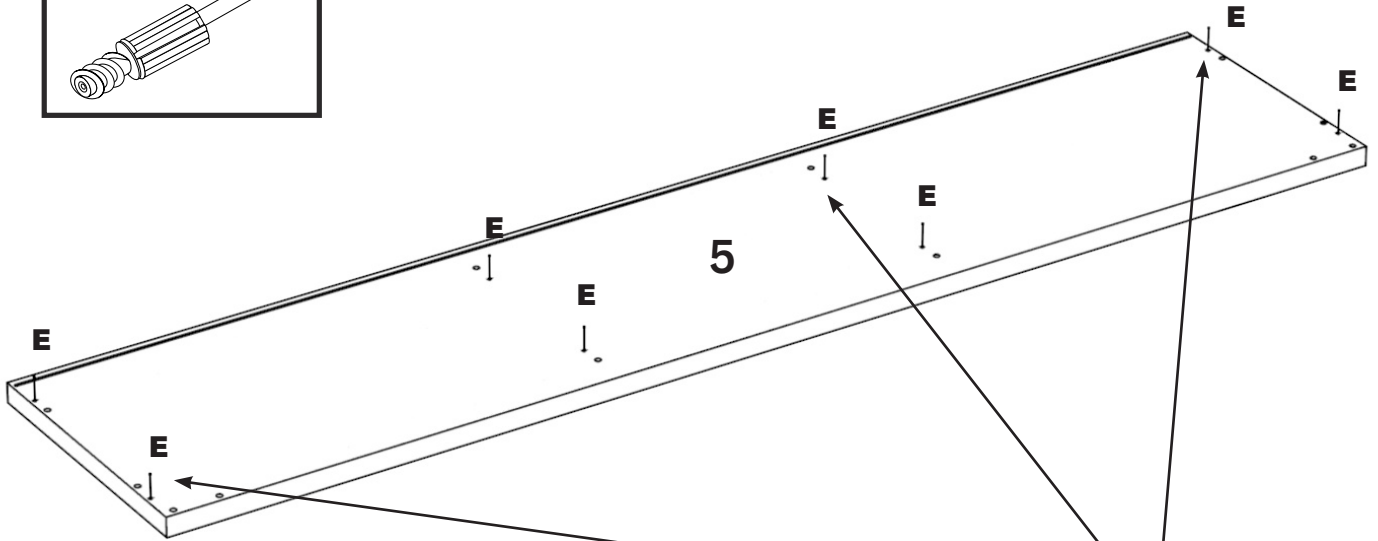
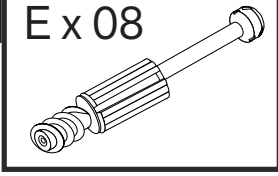

6 F x 04

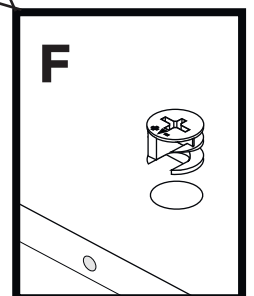
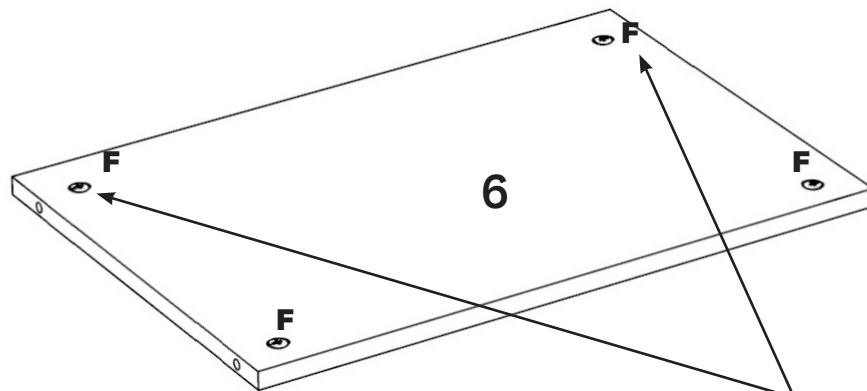
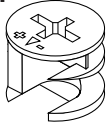

7

D x 04

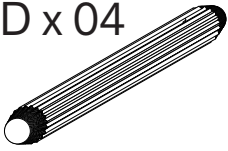

E x 04

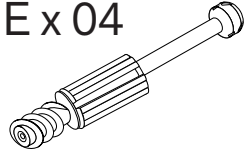

F x 04

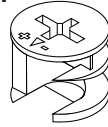

G x 04

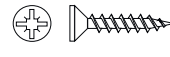

3.5 x 15 mm.

M x 02

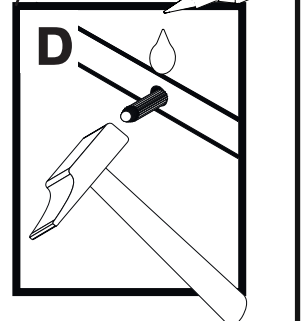
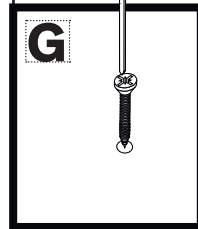
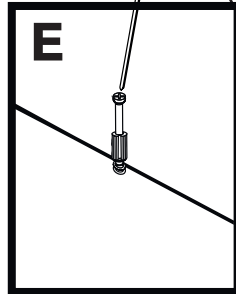
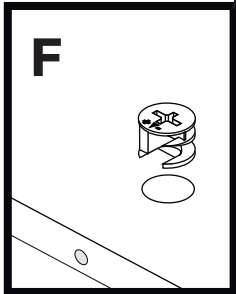
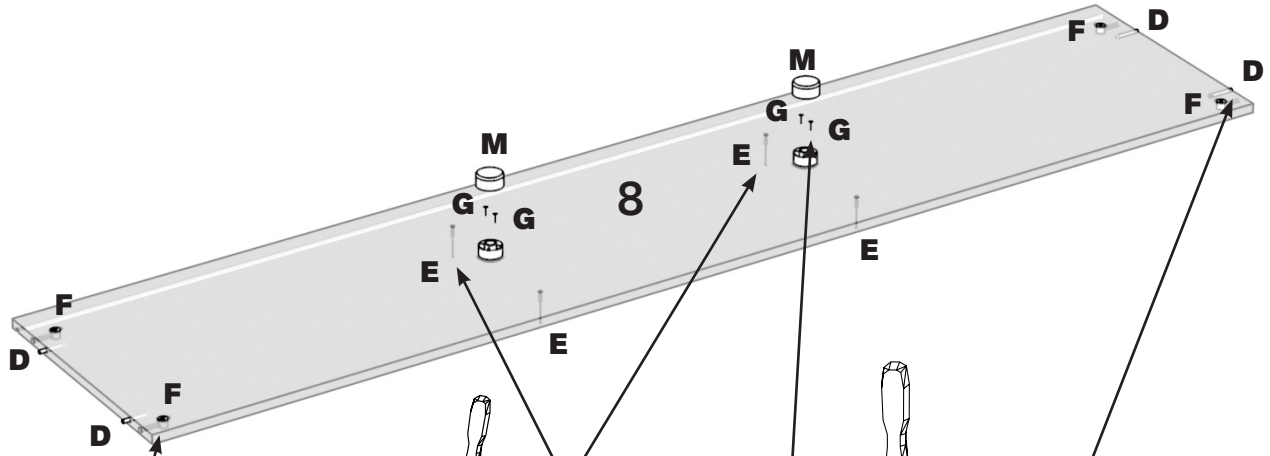
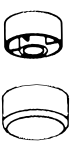

8

D x 04

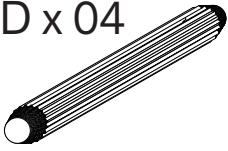

E x 06

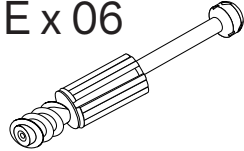

U x 04

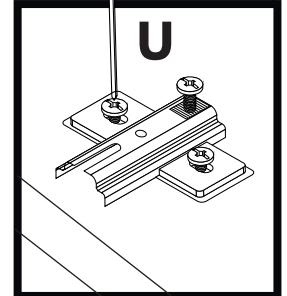
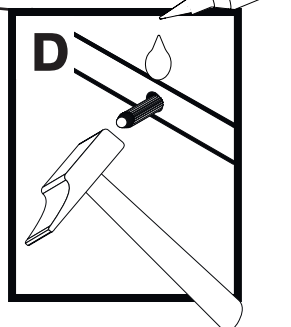
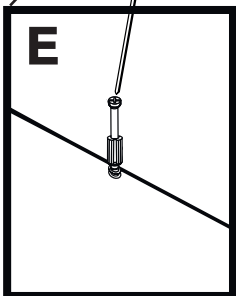
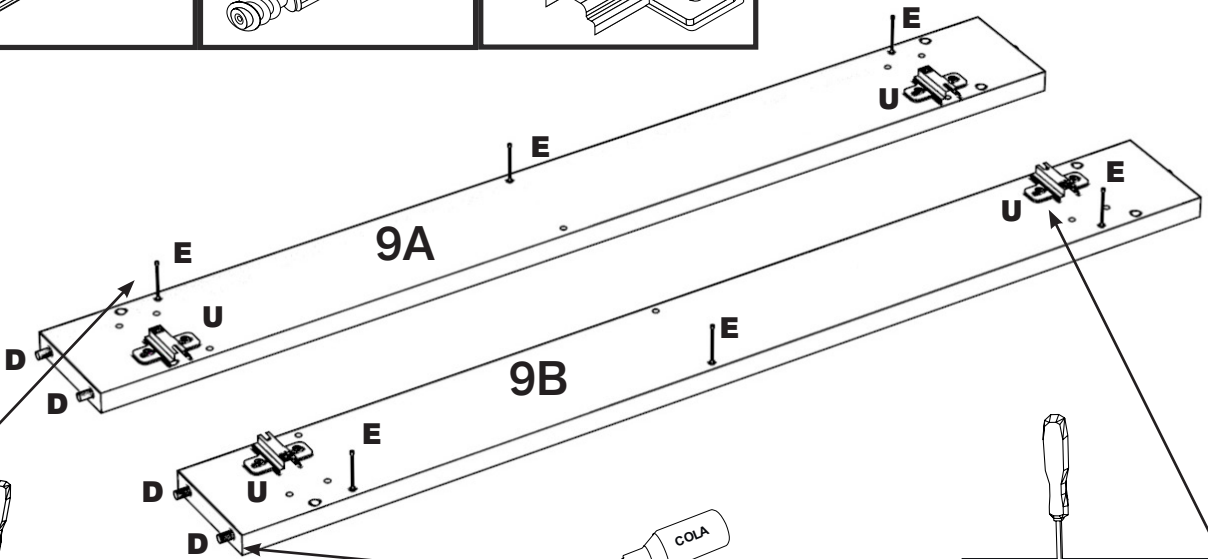
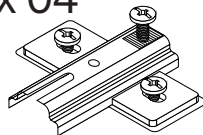

9

B x 02

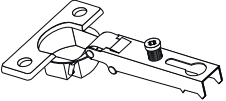

G x 04



3.5 x 15 mm.

I x 02

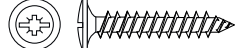

4 x 27 mm.

Q x 01

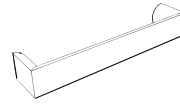

T x 02



7 mm.

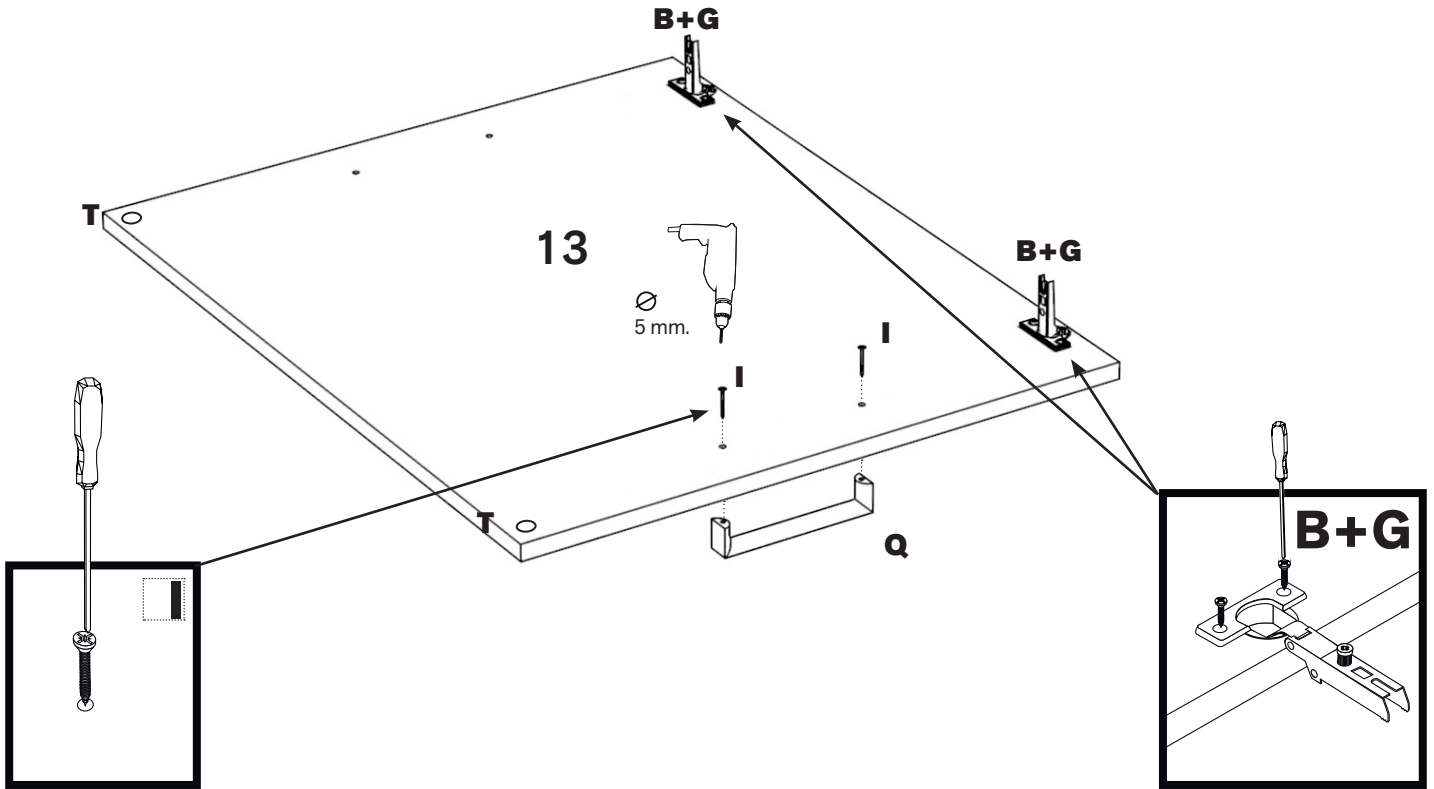

10

I x 02



4 x 27 mm.

Q x 01

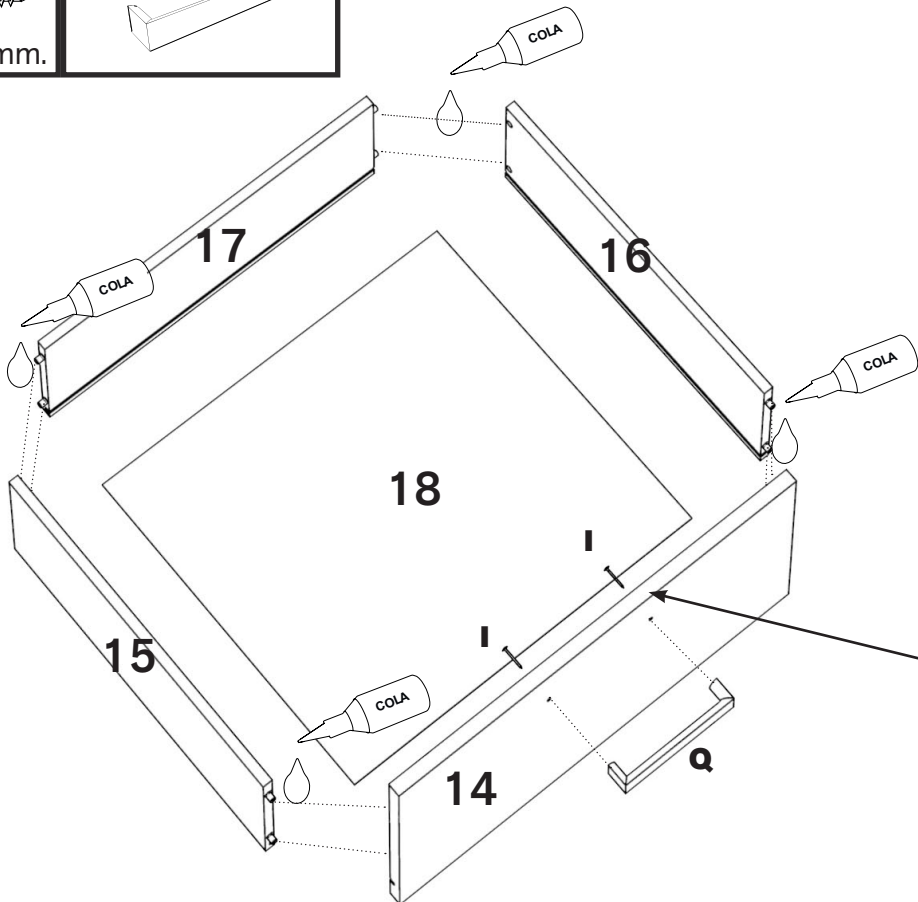
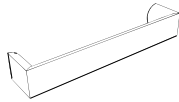

11

G x 04



3.5 x 15 mm.

T x 02



7 mm.

180°

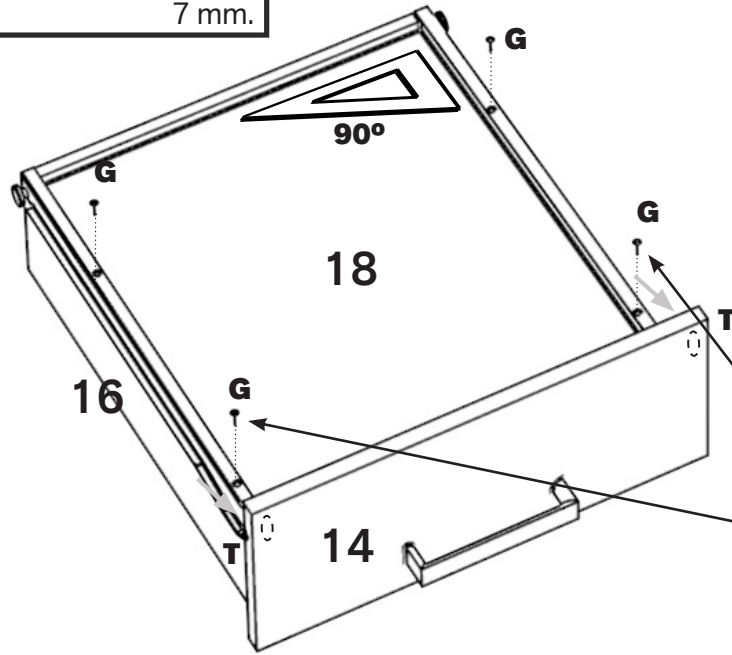

Secado 30m.
Drying 30m.
Secagem 30m.
Séchage 30m.

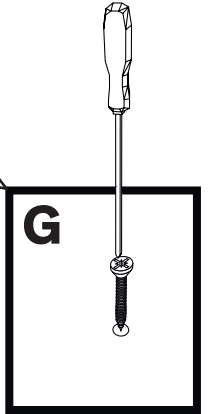

12

A x 04

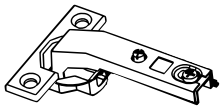

G x 04



3.5 x 15 mm.

I x 02

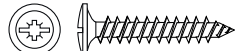

4 x 27 mm.

Q x 01

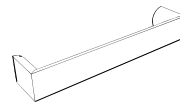





T x 01

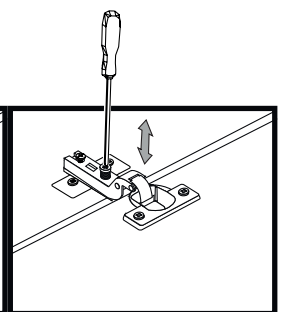
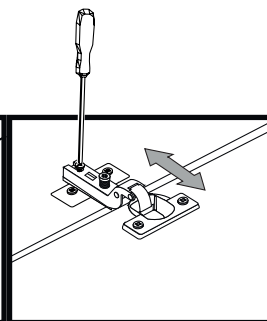
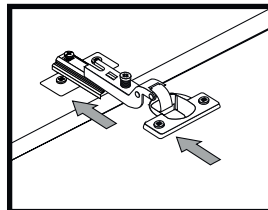
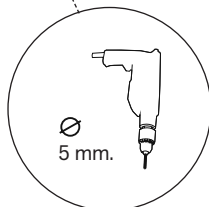
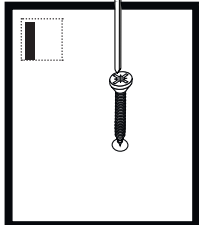
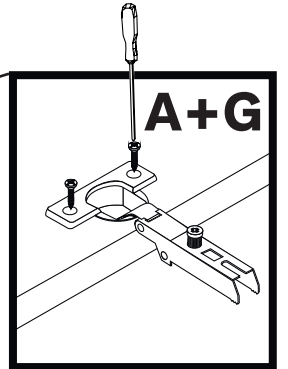
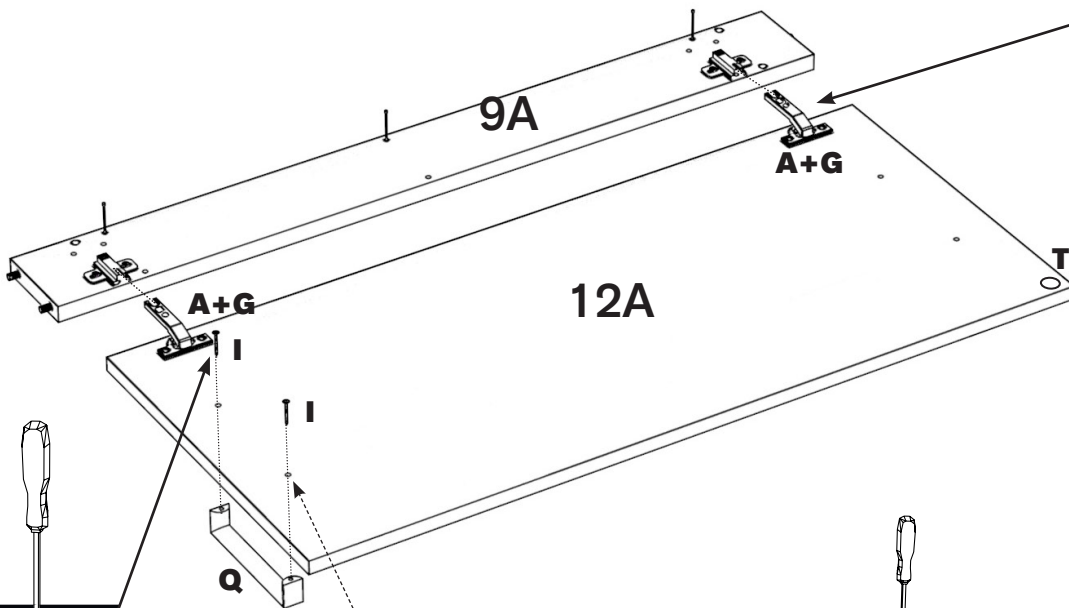

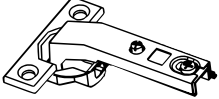
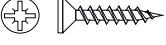
7 mm.

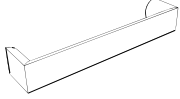

13	A x 04 	G x 04  3.5 x 15 mm.	I x 02  4 x 27 mm.	Q x 01 	T x 01  7 mm.
----	--	--	--	--	---

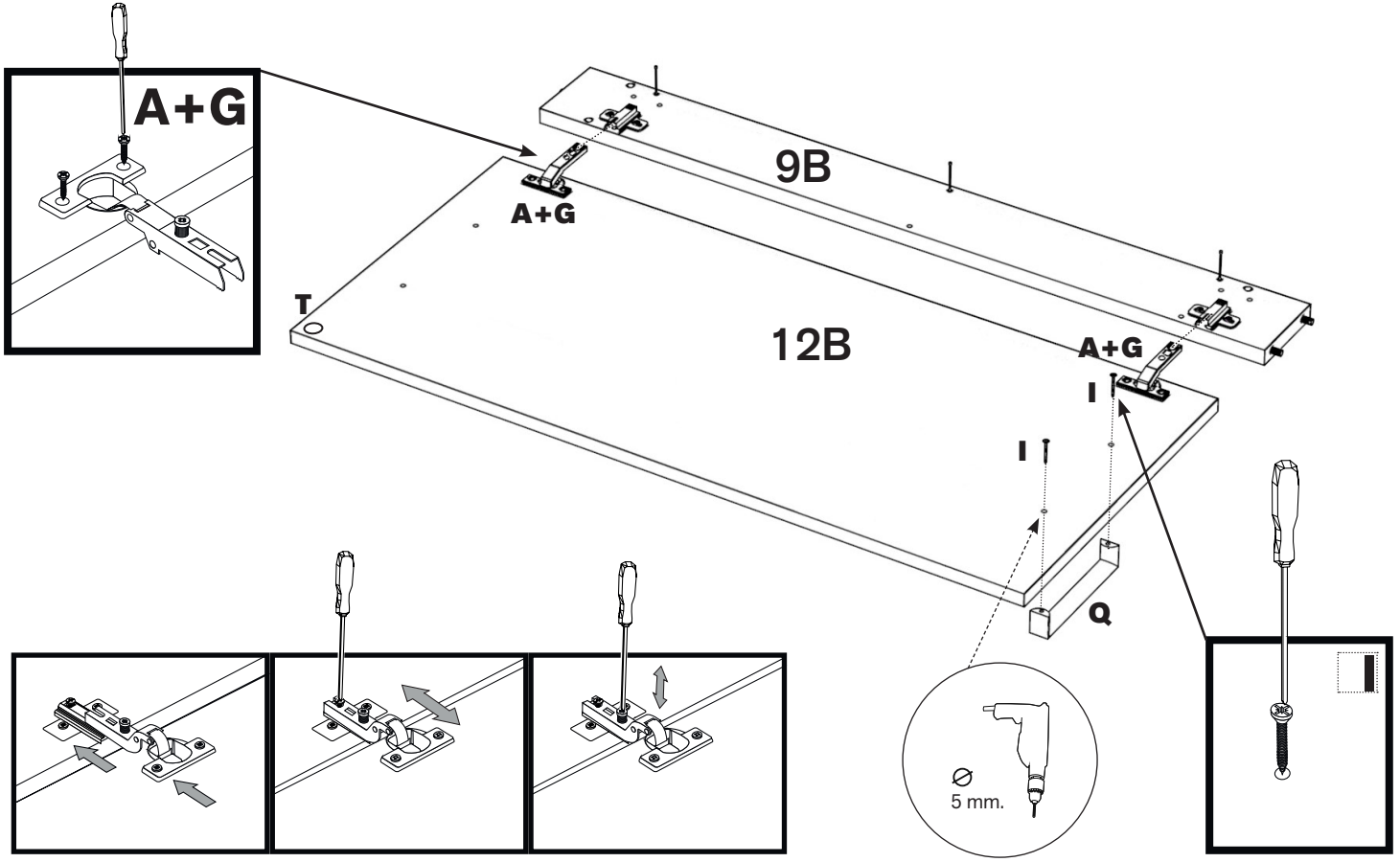

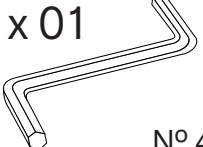
14	R x 01  N° 4
----	--

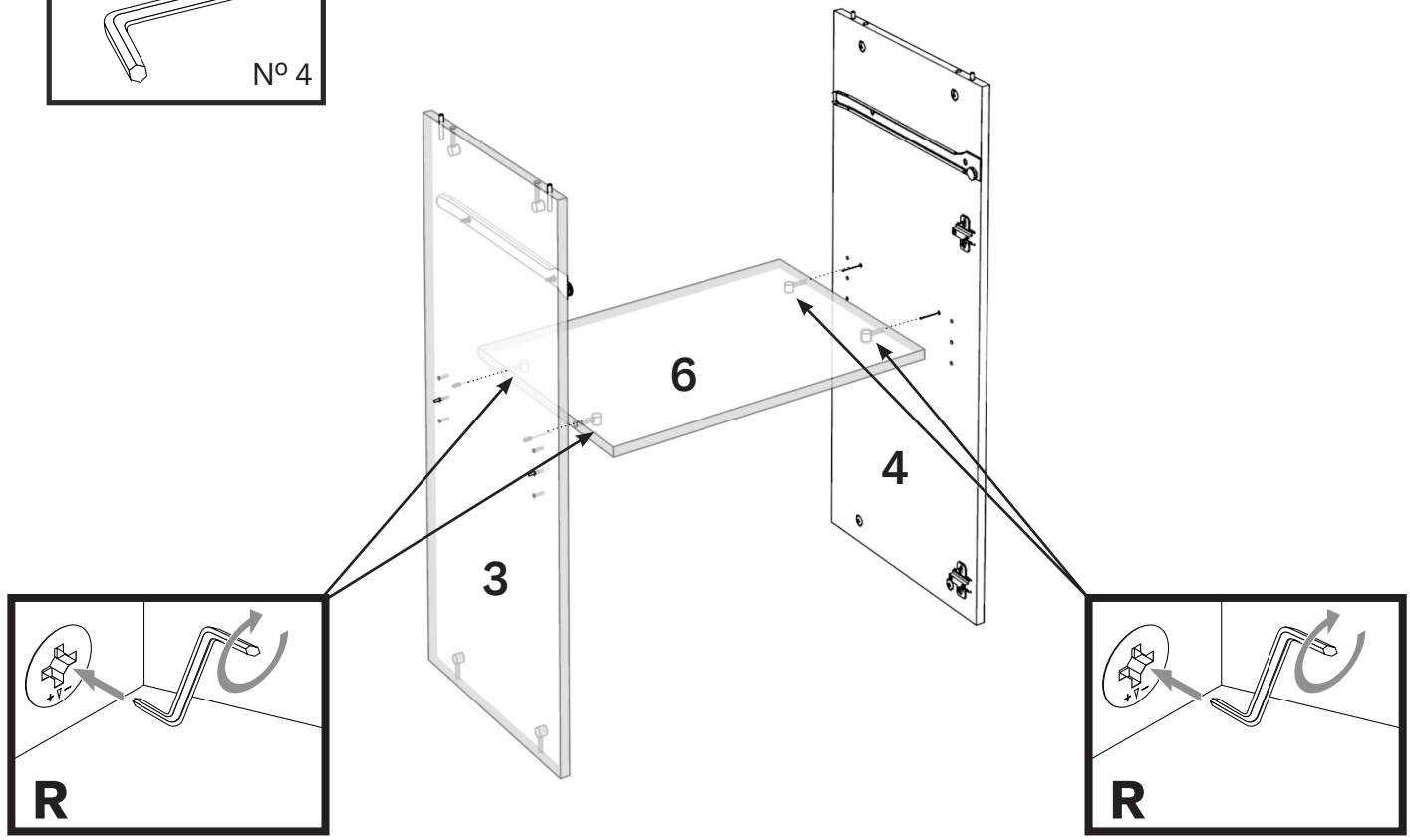

15

R x 01

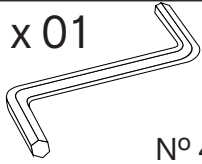

N° 4

S x 04

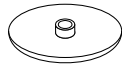

15 mm.

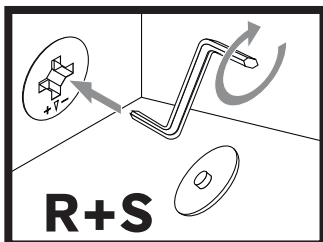
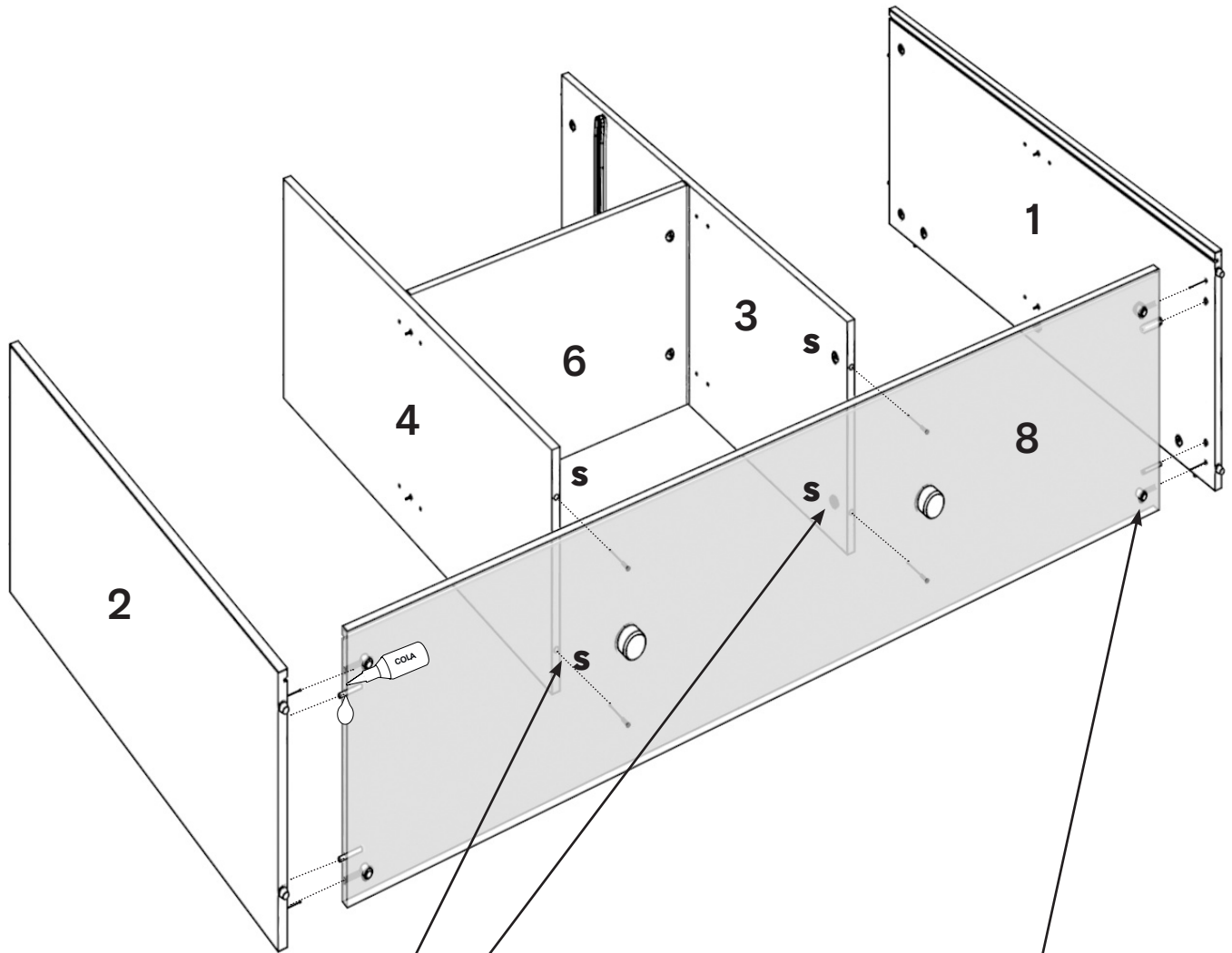

R+S

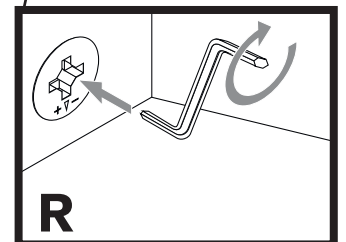

R

16

R x 01

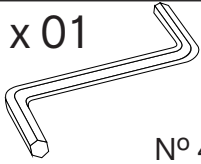

N° 4

S x 06

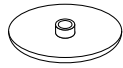

15 mm.

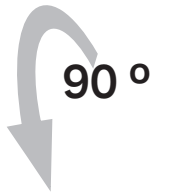

90°

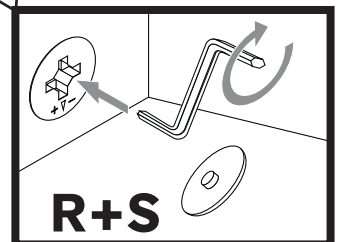
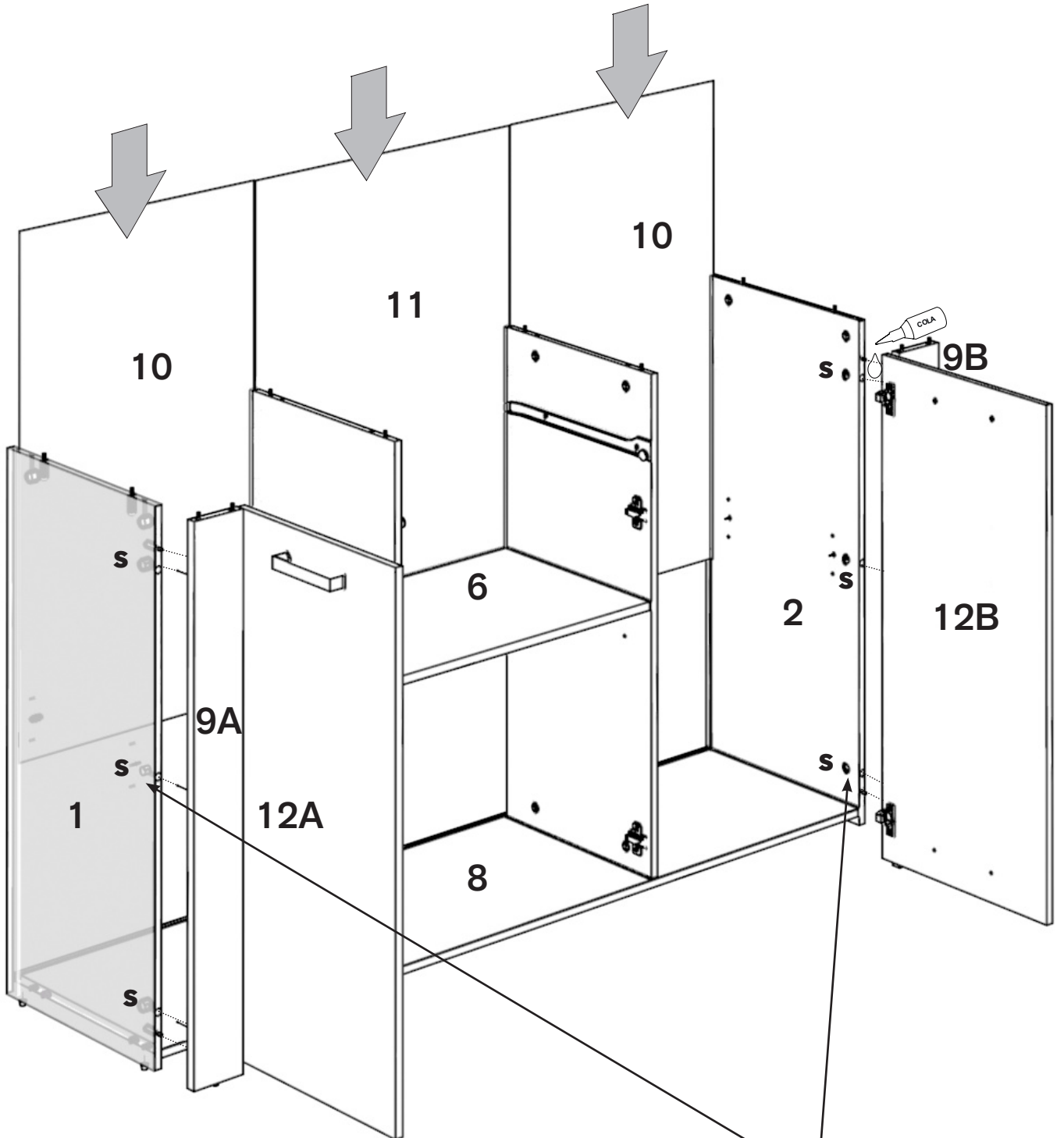

R+S

17 R x 01 N° 4 S x 04 15 mm.

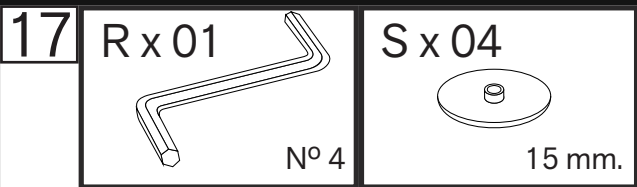
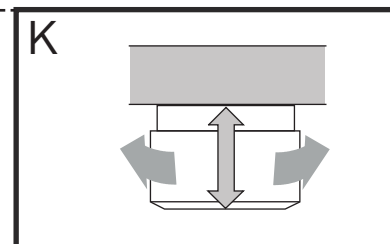
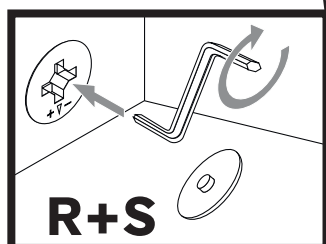
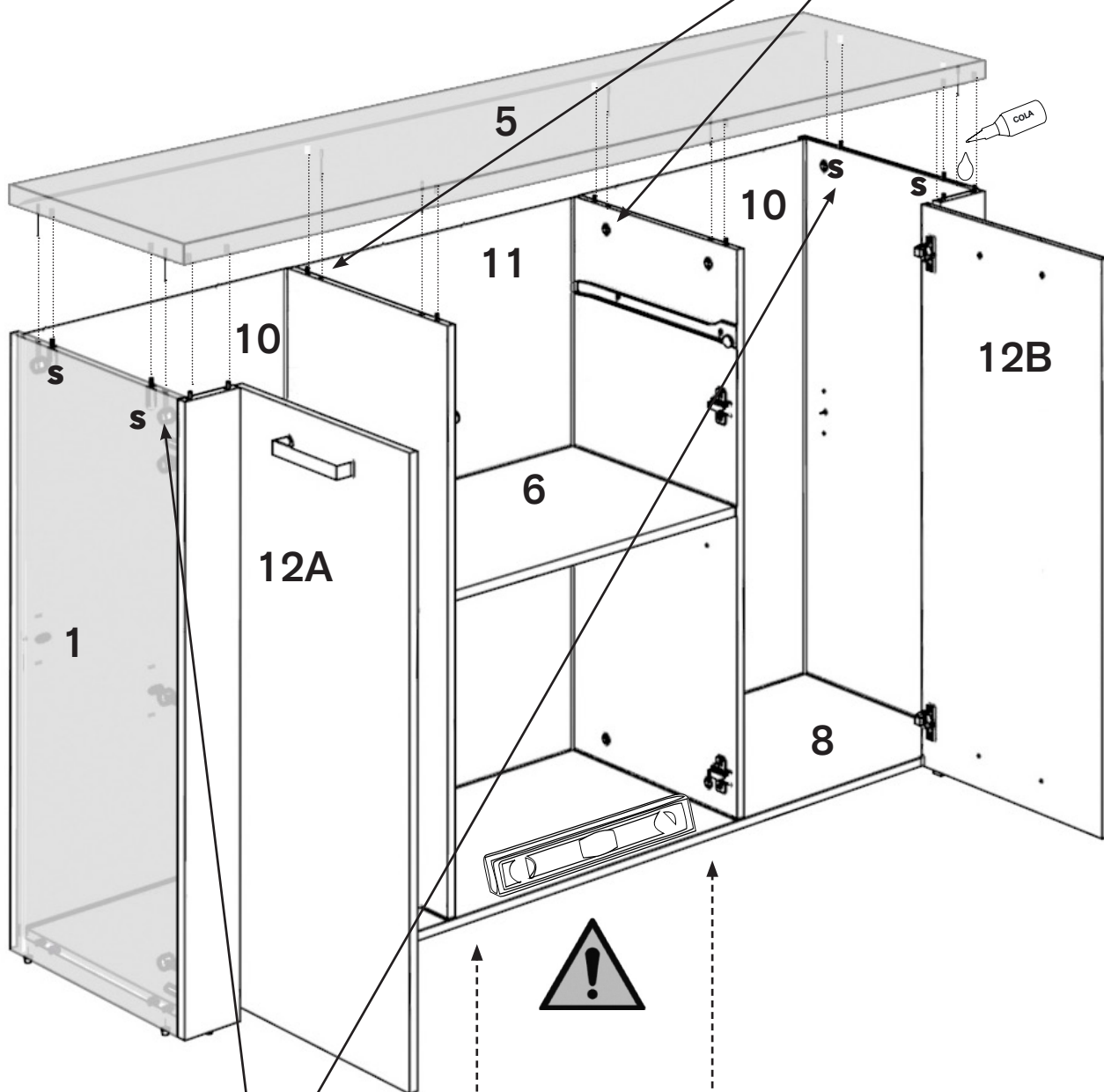
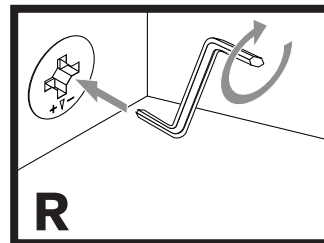
18

G x 08



3.5 x 15 mm.

H x 16

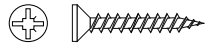

3.5 x 20 mm.

N x 10

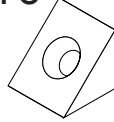

Ñ x 02

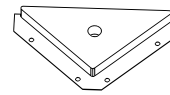

P x 06

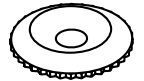

180°

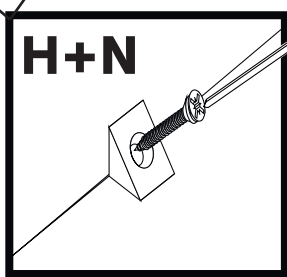
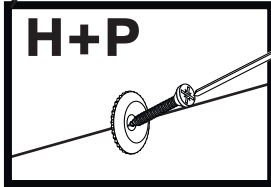
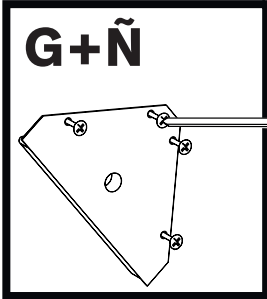
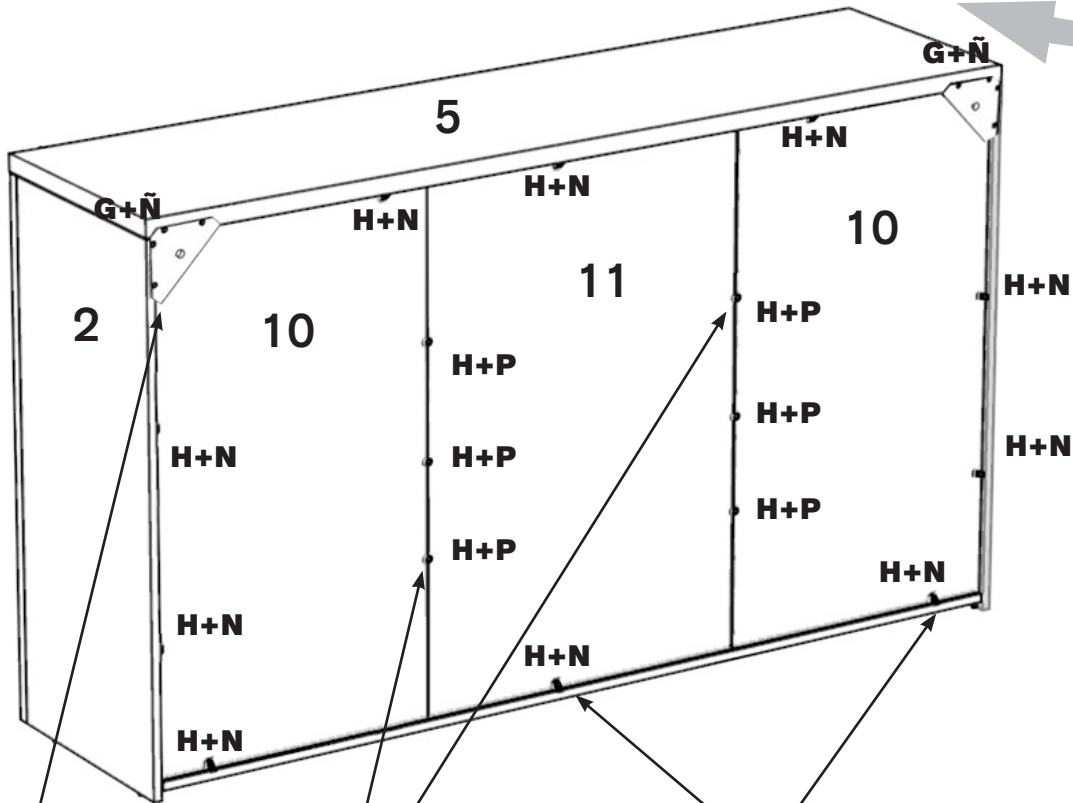

19

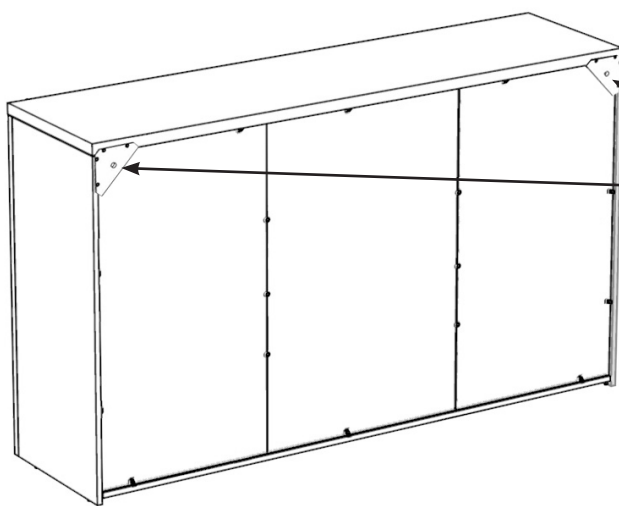

Español

Atención !!!

Antes de fijar el mueble a la pared compruebe su resistencia y naturaleza. En caso de que se suministren tacos y tornillos con el producto, éstos se destinan únicamente a los muros hechos con materiales sólidos y homogéneos. En caso de duda, consulte a un especialista, debiendo efectuar este montaje un operario especializado.

ADVERTENCIA: Con el fin de evitar la caída/vuelco, este mueble debe utilizarse siempre con el dispositivo de fijación de pared suministrado. Pueden producirse lesiones graves o fatales si vuelca un mueble. Para evitar que vuelque este mueble, debe fijarse permanentemente a la pared.

Deutsch

Achtung!!!

Bevor Sie die Möbel an der Wand befestigen, überprüfen Sie deren Festigkeit und Beschaffenheit. Falls Dübel und Schrauben im Lieferumfang des Produkts enthalten sind, sind diese nur für Wände aus festen und homogenen Materialien vorgesehen. Wenden Sie sich im Zweifelsfall an einen Fachmann, und ein Fachmann muss diese Montage durchführen.

WARNUNG: Wenn Möbelstücke umkippen, können ernste oder lebensgefährliche Verletzungen durch Einklemmen die Folge sein. Um zu verhindern, dass das Möbelstück umkippt, muss es fest an der Wand verankert werden.

Italiano

Attenzione!!!

Prima di fissare i mobili al muro, verifica prima la tipologia e resistenza del muro. Se viti e tasselli sono inclusi nell'offerta, essi sono utilizzabili solamente per i muri fatti di un certo tipo di materiale.

AVVERTENZA: Se il mobile si ribalta può causare lesioni da compressione serie o fatali. Per prevenire il rischio che il mobile si ribalti, quest'ultimo deve essere fissato permanentemente alla parete. Gli accessori per il fissaggio alla parete non sono inclusi perché pareti di materiali diversi richiedono tipi diversi di accessori di fissaggio. Usa sistemi di fissaggio adatti alle pareti della tua casa. Per maggiori dettagli, rivolgiti a un rivenditore specializzato.

English

Warning !!!

Before suspending or fixing to the wall check the type and strength of the wall. If the screws and dowels are supplied with the product, these are only intended for walls made of solid and homogeneous materials. In the case of doubts, contact a specialist, the installation must be performed by a competent person.

WARNING: Serious or fatal crushing injuries can occur from furniture tip-over. To prevent this furniture from tipping over, it must be permanently fixed to the wall.

Français

Attention!!!

Avant de suspendre le meuble ou de le fixer au mur, vérifiez au préalable le type et la résistance du mur. Utilisez les chevilles et les vis adaptées au type de mur. En cas de doute, consultez un spécialiste et un opérateur spécialisé doit effectuer cet assemblage.

AVERTISSEMENT: Risque de blessure grave en cas de chute du meuble. Pour éviter que ce meuble ne bascule, il faut le fixer au mur de façon permanente.

Português

Atenção!!!

Antes de pendurar ou fixar o móvel na parede, verifique com antecedência a sua natureza e resistência. Se o produto for acompanhado de buchas e parafusos, estes destinam-se só às paredes feitas com materiais sólidos e homogéneos. Em caso de dúvida, consulte um especialista. A montagem deve ser efetuado por uma pessoa competente.

IMPORTANTE: As quedas de móveis podem originar esmagamento ou morte. Estes móveis devem ser fixados à parede para evitar possíveis quedas.

20

O x 02

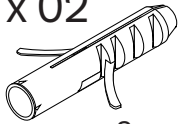

8 mm.

J x 02

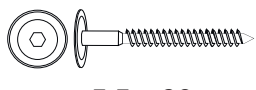

5,5 x 60 mm.

R x 01

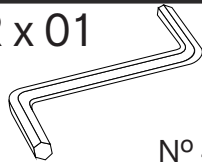

N° 4

180°

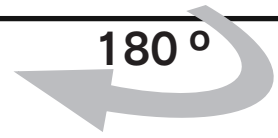

1

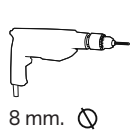

8 mm. Ø

2

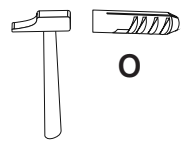

O

3

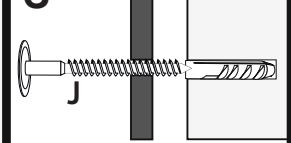

J

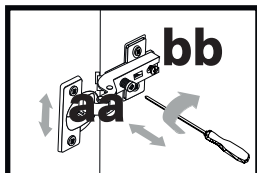
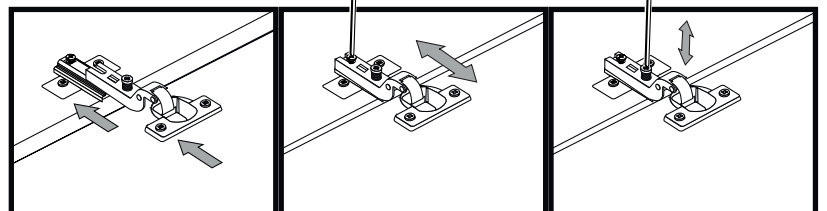
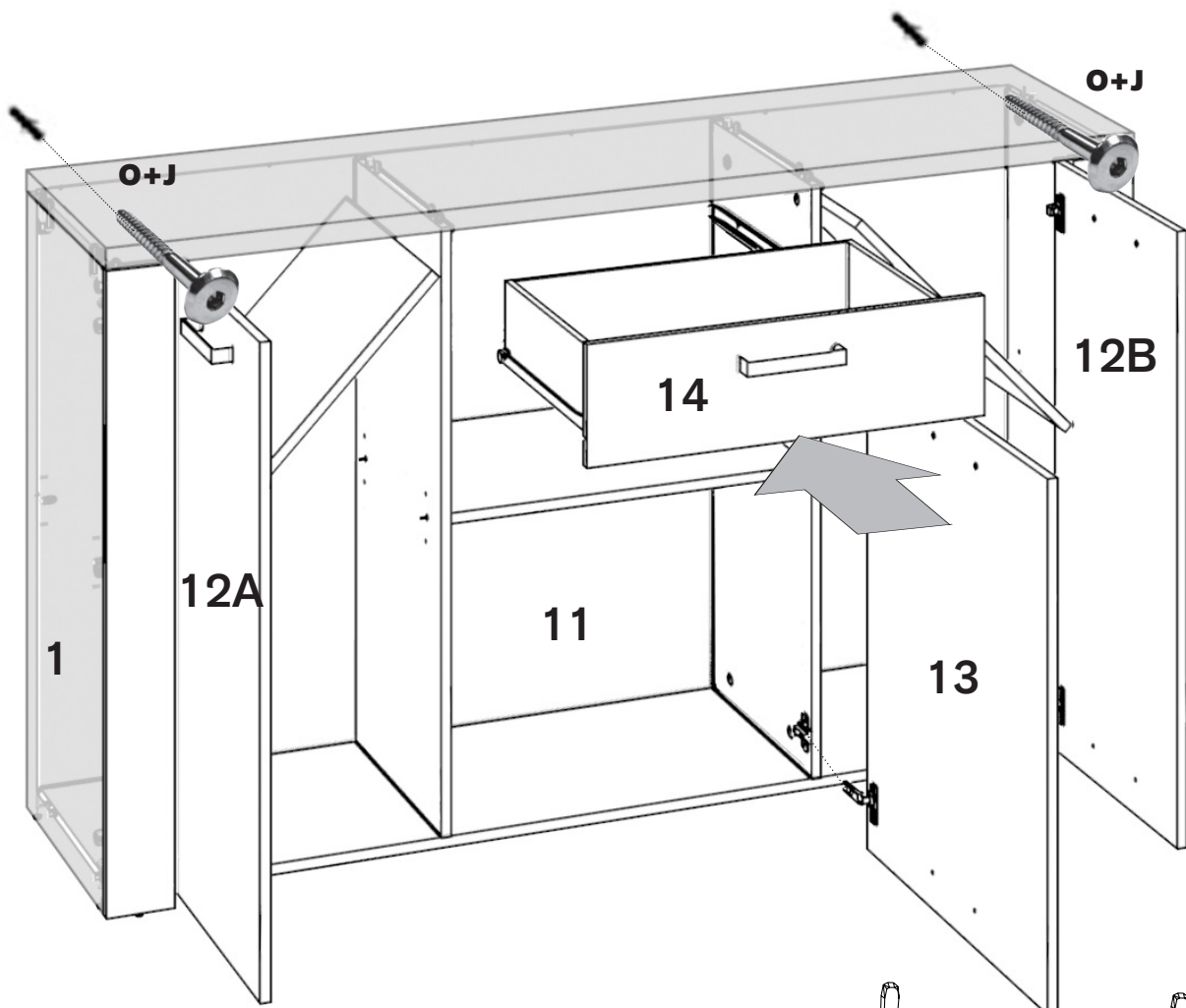
**EN**

Before to tighten the screw "aa", you have to slacken a little the screw "bb"

ES

Antes de apretar el tornillo "aa", hay que aflojar un poco el tornillo "bb"

FR

Avant de presser le vis "aa", il y a que relâcher un peu le vis "bb"

PT

Antes de apertar o parafuso "aa", deve desapertar um pouco o parafuso "bb"

IT

Prima di serrare la vite "aa", Allentare leggermente la vite "bb"

DE

Bevor die Schraube "aa" festgezogen wird lösen Sie ein wenig die schraub "bb"