

# MALIBÚ

## MANUAL DE INSTRUCCIONES

MANUAL DE INSTRUÇÕES  
MANUEL D'INSTRUCTIONS  
USER'S MANUAL



EAN: 8435059720166

 **NATERIAL**



# MALIBÚ

 NATERIAL

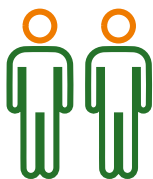

x2



5H



#### **RESISTENTE EN EL EXTERIOR**

RÉSISTANT À L'EXTÉRIEUR  
RESISTENTE AO AR LIVRE  
OUTDOOR RESISTANT



#### **INCLUYE CIERRE DE SEGURIDAD CON LLAVE**

COMPREND LA FERMETURE DE SÉCURITÉ AVEC LA CLÉ  
INCLUI O ENCERRAMENTO DA SEGURANÇA COM CHAVE  
INCLUDES SECURITY LOCKER WITH KEY



#### **PUERTA ABISAGRADA**

PORTE PIVOTANT SUR CHARNIÈRES  
PORTAS COM DOBRADIÇAS  
HINGED DOORS



#### **FÁCIL LIMPIEZA Y SIN MANTENIMIENTO**

FÁCIL LIMPEZA E MANUTENÇÃO  
FACILE À NETTOYER ET SANS ENTRETIEN  
EASY CLEANING AND MAINTENANCE FREE

# MANUAL DE INSTRUCCIONES

*A nuestros estimados clientes:*

## **Gracias por haber elegido uno de nuestros productos NATERIAL**

### **ANTES DE COMENZAR...**

Le aconsejamos que siga detenidamente este manual de instrucciones paso por paso para un correcto ensamblado del producto.

Asegúrese que tiene todas las piezas necesarias para su montaje.

Planifique la instalación del producto un día seco y sin viento. Evite el montaje en días con clima adverso para evitar daños en el producto o lesiones personales. La caseta no está diseñada para ser construida directamente sobre el césped.

Se recomienda el montaje sobre una base nivelada y firme de madera, un suelo llano de cemento o ladrillos o bloques cementados. Es muy importante fijar la caseta al suelo. Para ello la caseta dispone de unos agujeros en las piezas L1 que facilitan su fijación. No incluye tornillos ni otras piezas necesarias para su anclaje.

Si se hace una plataforma de concreto, es importante que se incline hacia los bordes para evitar la entrada de agua

Se debe ubicar el producto en un lugar resguardado del viento y con un buen drenaje. Evite colocarlo muy próximo a zonas con árboles, ya que será necesaria una limpieza regular de las ramas y hojas que pudieran caerle.

El montaje se debe realizar entre 2 personas al menos. Tenga siempre las herramientas a mano durante el montaje.

## HERRAMIENTAS NECESARIAS:



**NOTA IMPORTANTE:** Use guantes de trabajo, protección para los ojos, pantalón y camiseta de manga larga para realizar el montaje o cualquier mantenimiento del producto. Varias piezas de la caseta contienen bordes afilados.

## LIMPIEZA Y MANTENIMIENTO:

Se recomienda para su correcta conservación mantener limpio el producto, su limpieza se puede hacer con un trapo húmedo suave.

Nunca usar soluciones abrasivas ni detergentes sobre el producto.

Es importante mantener siempre limpios los desagües de la caseta para que no se acumule la suciedad en el tejado.

> **DESCUBRE OTROS PRODUCTOS DE ESTA COLECCIÓN:**  **NATERIAL**



**NEW PORT**



**MALIBÚ**



**HUNTINGTON**

# MANUAL DE INSTRUÇÕES

*Aos nossos estimados clientes:*

## **Obrigado por escolher um dos nossos produtos NATERIAL**

### **ANTES DE COMEÇAR, DEVE SABER...**

Aconselhamos que siga cuidadosamente este manual de instruções passo a passo para uma montagem correta do produto.

Certifique-se de que tem todas as peças necessárias para a sua montagem.

Planeje a instalação do produto num dia seco e sem vento. Evite montar em dias com condições meteorológicas adversas para evitar danos no produto ou ferimentos pessoais. O abrigo não foi concebido para ser construído diretamente no relvado.

Recomenda-se a montagem numa base de madeira nivelada e firme, num piso plano de cimento ou tijolos ou blocos cimentados. É muito importante fixar o abrigo no chão. Para o efeito, o abrigo tem furos nas peças L1 que facilitam a sua fixação. Não inclui parafusos ou outras peças necessárias para a fixação.

Se for feita em uma plataforma de betão, é importante que se incline para as bordas para evitar que a água entre no abrigo.

O produto deve estar localizado num local protegido do vento e com boa drenagem. Evite colocá-lo muito perto de áreas com árvores porque então seria necessária uma limpeza regular de ramos e folhas que possam cair.

A montagem deve ser feita pelo menos entre duas pessoas. Mantenha sempre as ferramentas à mão durante a montagem.

## FERRAMENTAS NECESSÁRIAS:



**NOTA IMPORTANTE:** Use luvas de trabalho, proteção ocular, calças e camisetas de manga comprida para realizar montagem ou qualquer manutenção do produto. Várias peças do abrigo contêm bordas afiadas.

## LIMPEZA E MANUTENÇÃO:

Recomenda-se para uma conservação adequada manter o produto limpo, a sua limpeza pode ser feita com um pano húmido suave.

Nunca utilize soluções abrasivas ou detergentes no produto.

É importante manter sempre os esgotos limpos para que a sujidade não se acumule no telhado.

> **DESCUBRA** OUTROS PRODUTOS DESTA COLEÇÃO:

 **MATERIAL**



**NEW PORT**



**MALIBÚ**



**HUNTINGTON**

# MANUEL D'INSTRUCTIONS

*À nos chers clients:*

## **Merci d'avoir choisi l'un de nos produits NATERIAL**

### **AVANT DE COMMENCER, VOUS DEVEZ SAVOIR...**

Nous vous conseillons de suivre attentivement ce mode d'emploi étape par étape pour un montage correct du produit.

Assurez-vous d'avoir toutes les pièces nécessaires pour l'assemblage.

Prévoyez d'installer le produit par temps sec et sans vent. Évitez le montage les jours de mauvais temps pour éviter d'endommager le produit ou de vous blesser. La maison n'est pas conçue pour être construite directement sur la pelouse.

Le montage sur une base de bois ferme et de niveau, sur un sol en ciment plat ou sur de la brique ou du bloc de ciment est recommandé. Il est très important de fixer l'abri de de jardin au sol. Pour cela, l'abri de jardin a des trous dans les pièces L1 qui facilitent sa fixation. Il ne comprend pas de vis ou d'autres pièces nécessaires à son ancrage.

Si une terrasse en béton est fabriquée, il est important de se pencher vers les bords pour éviter la pénétration d'eau

Le produit doit être placé dans un endroit à l'abri du vent et avec un bon drainage. Évitez de le placer très près de zones arborées, car il sera nécessaire de nettoyer régulièrement les branches et les feuilles qui pourraient tomber.

Le montage doit être effectué entre 2 personnes au minimum. Gardez toujours les outils à portée de main pendant le montage.



## OUTILS NÉCESSAIRES:



**NOTA IMPORTANTE:** Portez des gants de travail, des lunettes de protection, un pantalon et une chemise à manches longues pour l'assemblage ou tout entretien du produit. Plusieurs pièces de la maison ont des arêtes vives.

## NETTOYAGE ET ENTRETIEN:

N'utilisez jamais de solutions abrasives ou de détergents sur le produit.

Il est important de toujours garder les drains de l'abri propres afin que la saleté ne s'accumule pas sur le toit.

Il est recommandé pour sa bonne conservation de garder le produit propre, son nettoyage peut se faire avec un chiffon doux et humide.

> **DÉCOUVREZ D'AUTRES PRODUITS DE CETTE COLLECTION:**  **NATERIAL**



**NEW PORT**



**MALIBÚ**



**HUNTINGTON**

# USER'S MANUAL

*Dearest customer:*

**Thank you for choosing one  
of our NATERIAL products**

## **BEFORE YOU START YOU SHOULD KNOW...**

We advise you to carefully follow this instruction manual step by step for a correct assembly of the product.

Make sure you have all the necessary parts for assembly.

Plan to install the product on a dry, windless day. Avoid assembly on adverse weather days to avoid product damage or personal injury. The shed is not designed to be built directly on the lawn.

Mounting on a level, firm base of wood, a flat cement floor, or cemented brick or block is recommended. It is very important to fix the house to the ground. To do this, the box has holes in the L1 pieces that facilitate its fixing. It does not include screws or other necessary parts for its anchorage.

If a concrete deck is made, it is important to lean toward the edges to prevent water ingress

The product should be located in a place sheltered from the wind and with good drainage. Avoid placing it very close to areas with trees, as regular cleaning of branches and leaves that require falling will be necessary.

The assembly must be carried out between 2 people at least. Always keep tools on hand during assembly.

## TOOLS NEEDED:



**IMPORTANT NOTE:** Wear work gloves, eye protection, pants and a long-sleeved shirt for assembly or any maintenance of the product. Several pieces of the shed contain sharp edges.

## CLEANING AND MAINTENANCE:

It is recommended for its correct conservation to keep the product clean, its cleaning can be done with a soft damp cloth.

Never use abrasive solutions or detergents on the product.

It is important to always keep the house drains clean so that dirt does not accumulate on the roof.

> **DISCOVER OTHER PRODUCTS IN THIS COLLECTION:**

 **NATERIAL**



**NEW PORT**



**MALIBÚ**



**HUNTINGTON**

# GARANTÍA

10

AÑOS  
GARANTÍA

La gama completa de casetas, armarios y arcones de 0.40 mm MATERIAL se fabrica con materiales de óptima calidad y bajo estrictos controles y estándares de calidad. En caso de ocurrir algún inconveniente en el producto adquirido, rogamos se ponga en contacto con el servicio de atención al cliente en el teléfono 902300299 o a través del correo electrónico info@okoru.es.

La garantía es válida a partir de la fecha de compra que aparece en el ticket o factura, el cual deberá presentarse para hacer uso de la garantía.

El periodo de garantía de este producto es de 10 años contra todo inconveniente o fallo consecuencia de un defecto estructural o decoloración.

## QUEDAN EXCLUIDAS DE LA GARANTÍA:

- › La no conformidad con el transporte. Hay que comunicárselo a la agencia de transportes en el plazo indicado en el albarán una vez recibido el producto.
- › Las roturas, daños generados por inclemencias meteorológicas como pueden ser fuertes vientos, granizo, riadas etc...
- › El mal montaje, uso incorrecto y consecuencias derivadas de ello.
- › El no mantenimiento y piezas con desgaste como son los amortiguadores, bombín, manilla y bisagras
- › Las piezas plásticas.
- › La limpieza o mantenimiento con productos abrasivos.
- › Daños por corrosión en piezas o chapas en zonas intermitentes, zonas dañadas de forma indirecta o por estar expuesto a zonas marítimas con salinidad provocando corrosión. Quedan excluidos de garantía daños por corrosión en aristas o esquinas de piezas.
- › La decoloración provocada por el paso del tiempo
- › Los rayones en la pintura
- › Los golpes o abollones en la chapa
- › El no presentar la factura o ticket de venta y la no notificación en plazo y forma.
- › Los costes generados por el tratamiento de piezas defectuosas o dañadas, así como la responsabilidad por daños indirectos que se puedan dar
- › Uso comercial o con un propósito diferente del personal o doméstico
- › Modificaciones, pinturas o armado no realizados de conformidad con la ley de garantías y explicaciones del manual de instrucciones, así como los daños causados por exceder la capacidad de carga de almacenamiento del producto.

# GARANTIA

A gama completa de abrigos, armários e baús de 0,40 mm MATERIAL é fabricada com materiais de ótima qualidade e com rigorosos controles e padrões de qualidade. Em caso de qualquer inconveniente no produto adquirido, entre em contato com o atendimento ao cliente pelo telefone 902300299 ou pelo e-mail info@okoru.es.

A garantia é válida a partir da data da compra que aparece no ticket ou na fatura, que deve ser apresentada para fazer uso da garantia.

O período de garantia deste produto é de 10 anos contra qualquer inconveniente ou falha resultante de defeito estrutural ou descoloração.

## **ESTÃO EXCLUÍDOS DA GARANTIA:**

- › Não conformidade com transporte. Deve ser comunicado à agência de transporte dentro do prazo indicado na nota de entrega assim que o produto for recebido.
- › Quebras, danos causados por intempéries, como ventos fortes, granizo, inundações etc.
- › Montagem incorreta, uso incorreto e consequências derivadas deles.
- › Peças que não foram adequadamente mantidas e com desgaste derivado do uso habitual, como amortecedores, cilindro, manopla e dobradiças.
- › Peças plásticas.
- › Limpeza ou manutenção com produtos abrasivos.
- › Danos por corrosão em peças ou placas em áreas intermitentes, áreas indiretamente danificadas ou exposição a áreas do mar com salinidade, causando corrosão. Os danos por corrosão nas bordas ou nos cantos das peças são excluídos da garantia.
- › A descoloração causada pela passagem do tempo.
- › Arranhões na pintura original.
- › Solavancos ou ondulações na folha.
- › Falha em apresentar a fatura ou o ticket de vendas e a não notificação no devido tempo e formulário.
- › Os custos gerados pelo tratamento de peças defeituosas ou danificadas, bem como a responsabilidade por danos indiretos que possam ocorrer.
- › Uso comercial ou para outros fins que não pessoais ou domésticos.
- › Modificações, tintas ou montagens não realizadas de acordo com a lei de garantias e explicações do manual de instruções, bem como os danos causados por exceder a capacidade de armazenamento do produto.

**10****ANS**  
GARANTIE

# GARANTIE

La gamme complète d'abris de jardin, armoires de jardin et coffres de jardin de 0,40 mm NATERIA est fabriquée avec des matériaux de qualité optimale et sous des contrôles et normes de qualité stricts. En cas de problème avec le produit acheté, veuillez contacter le service clientèle au 902300299 ou par courrier électronique à [info@okoru.es](mailto:info@okoru.es).

La garantie est valable à partir de la date d'achat figurant sur la preuve d'achat ou la facture, qui doit être présentée pour pouvoir utiliser la garantie.

La période de garantie de ce produit est de 10 ans contre tout inconvénient ou toute défaillance résultant d'un défaut de structure ou d'une décoloration.

## ILS SONT EXCLUS DE LA GARANTIE:

- › Non-conformité avec le transport. Il doit être communiqué à l'agence de transport dans le délai indiqué sur le bon de livraison une fois le produit reçu.
- › Pauses, dommages causés par des conditions météorologiques défavorables, tels que vents violents, grêle, inondations, etc.
- › Mauvais assemblage, utilisation incorrecte et conséquences qui en découlent.
- › Pièces d'usure telles que les amortisseurs, le cylindre, la poignée et les charnières pièces en plastique.
- › Nettoyage ou entretien avec des produits abrasifs.
- › Dommages causés par la corrosion à des pièces ou des plaques dans des zones intermittentes, indirectement endommagées ou exposées à des zones marines salines causant la corrosion. Les dommages dus à la corrosion sur les arêtes ou les coins de pièces sont exclus de la garantie.
- › La décoloration causée par le passage du temps
- › Rayures dans la peinture
- › Des bosses ou des boucles sur la feuille
- › Défaut de présenter la facture ou la preuve d'achat et la non-notification dans les délais et sous la forme.
- › Les coûts engendrés par le traitement des pièces défectueuses ou endommagées, ainsi que la responsabilité des dommages indirects pouvant survenir
- › Utilisation commerciale ou à des fins autres que personnelles ou domestiques
- › Les modifications, peintures ou assemblages non effectués conformément à la loi sur les garanties et les explications du manuel d'instructions, ainsi que les dommages causés par le dépassement de la capacité de stockage du produit.

# WARRANTY

The complete range of cabinets, cabinets and bunkers of 0.40 mm MATERIAL is manufactured with materials of optimum quality and under strict controls and quality standards. In case of any inconvenience in the purchased product, please contact customer service at 902300299 or via email [info@okoru.es](mailto:info@okoru.es).

The guarantee is valid from the date of purchase that appears on the ticket or invoice, which must be presented to make use of the guarantee.







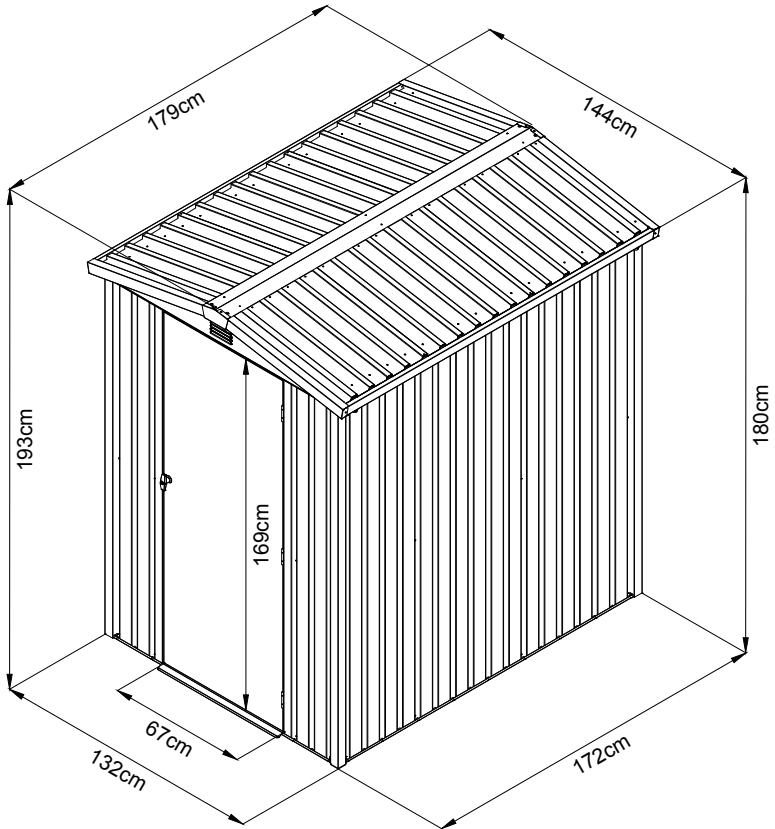









The warranty period of this product is 10 years against any inconvenience or failure resulting from a structural defect or discoloration.











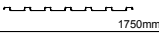

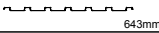

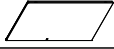

## THEY ARE EXCLUDED FROM THE GUARANTEE:

- › Nonconformity with transportation. It must be communicated to the transport agency within the deadline indicated on the delivery note once the product is received.
- › Breaks, damage caused by inclement weather such as high winds, hail, floods etc.
- › Bad assembly, incorrect use and consequences derived from it.
- › Non-maintenance and wear parts such as shock absorbers, cylinder, handle and hinges.
- › Plastic parts.
- › Cleaning or maintenance with abrasive products.
- › Corrosion damage to parts or plates in intermittent areas, indirectly damaged areas or being exposed to sea areas with salinity causing corrosion. Corrosion damage on edges or corners of parts are excluded from the guarantee.
- › The discoloration caused by the passage of time.
- › Scratches in the paint.
- › Bumps or curls on the panels.
- › Failure to present the invoice or sales ticket and the non-notification in due time and form.
- › The costs generated by the treatment of defective or damaged parts, as well as the responsibility for indirect damages that may occur.
- › Commercial use or for a purpose other than personal or domestic.
- › Modifications, paints or assembly not carried out in accordance with the law of guarantees and explanations of the instruction manual, as well as the damages caused by exceeding the storage capacity of the product.





NO.	PART	Qty.
1	 1260mm	2
2	 1260mm	2
3	 1660mm	2
4	 1660mm	2
5	 722mm	1
6	 722mm	1
7	 1750mm	1
8	 1750mm	1
20	 1718mm	2
12	 1788mm	2
13	 734mm	2
14	 734mm	2
16	 1750mm	4
21	 2	2
18	 1788mm	1
19	 1788mm	1
GE	 2	2

NO.	PART	Qty.
P1	 1750mm	6
P3	 1750mm	6
P7	 643mm	4
P9	 643mm	4
D2	 1716mm	1
L1	 8	8
K1	 4	4
GS	 4	4
B6	 2	2
GB	 1	1
F1	 210	210
F2	 34	34
F3	 14	14
S2	 60	60
S3	 156	156
K3	 2	2

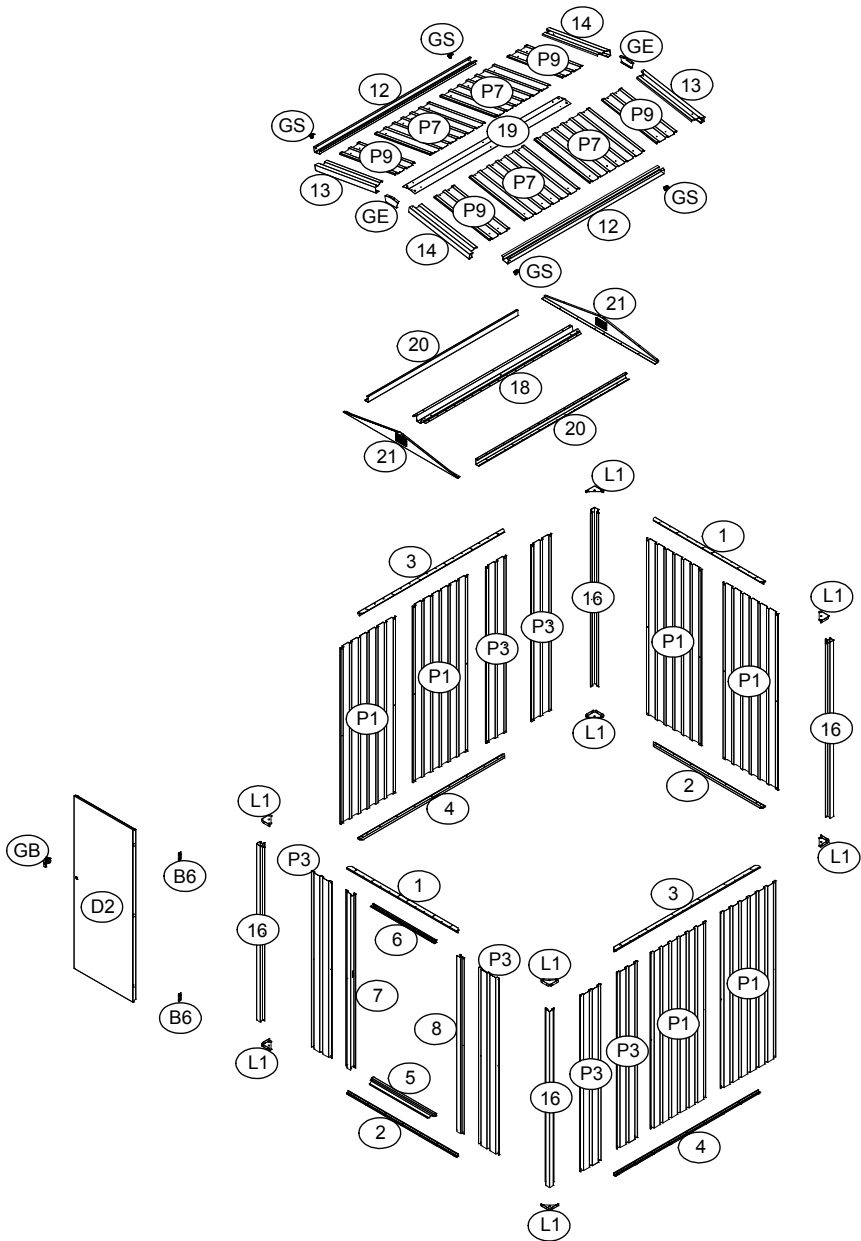

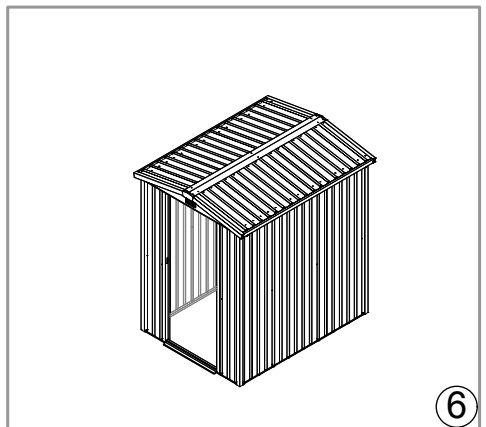
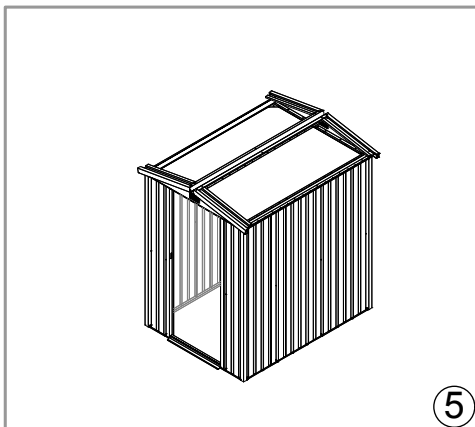
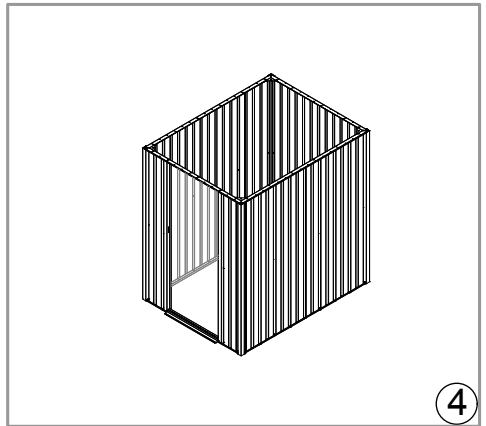
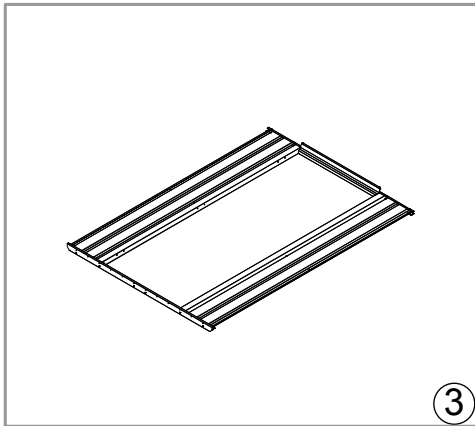
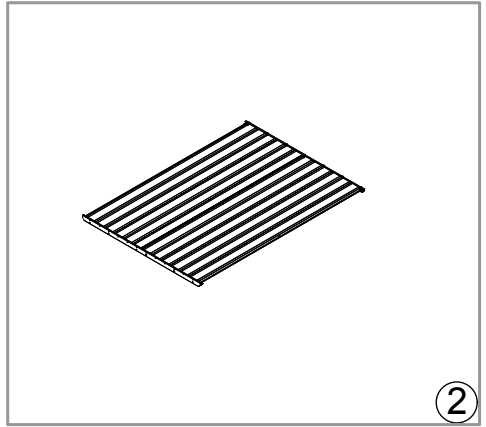
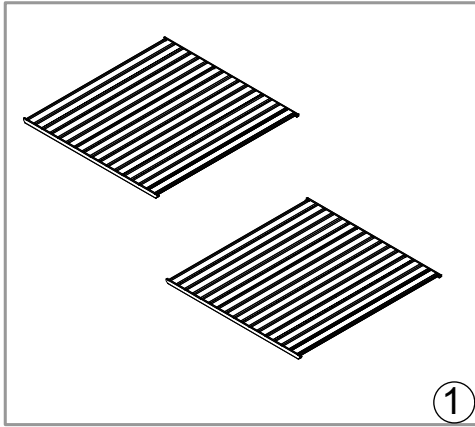

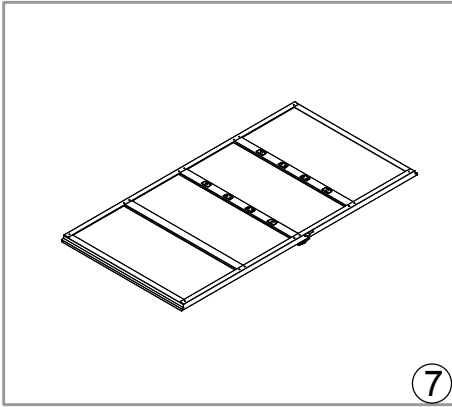

7

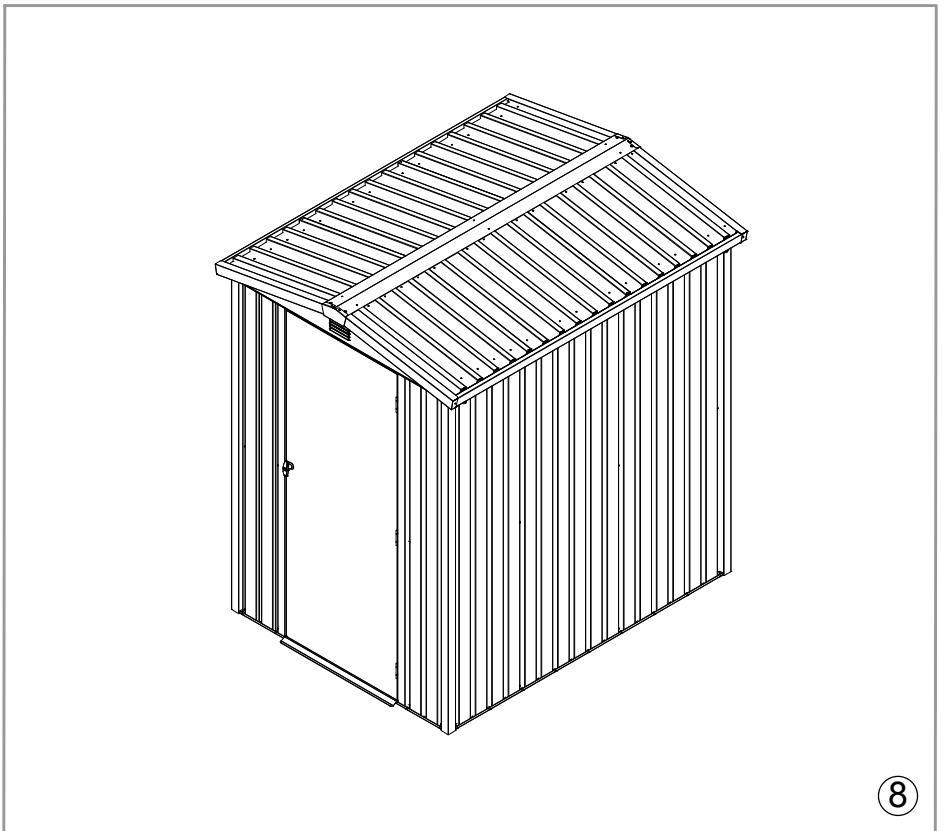







8

## PASO 1: PANELES LATERALES (X2)

ETAPA 1: PAINÉIS LATERAIS (X2)

ÉTAPE 1: PANNEAUX LATÉRAUX (X2)

STEP 1: SIDE WALLS (2X)

NO.	PART	Qty.
3		2
4		2
P1		4
P3		4
F2		6
F1		12
S3		18

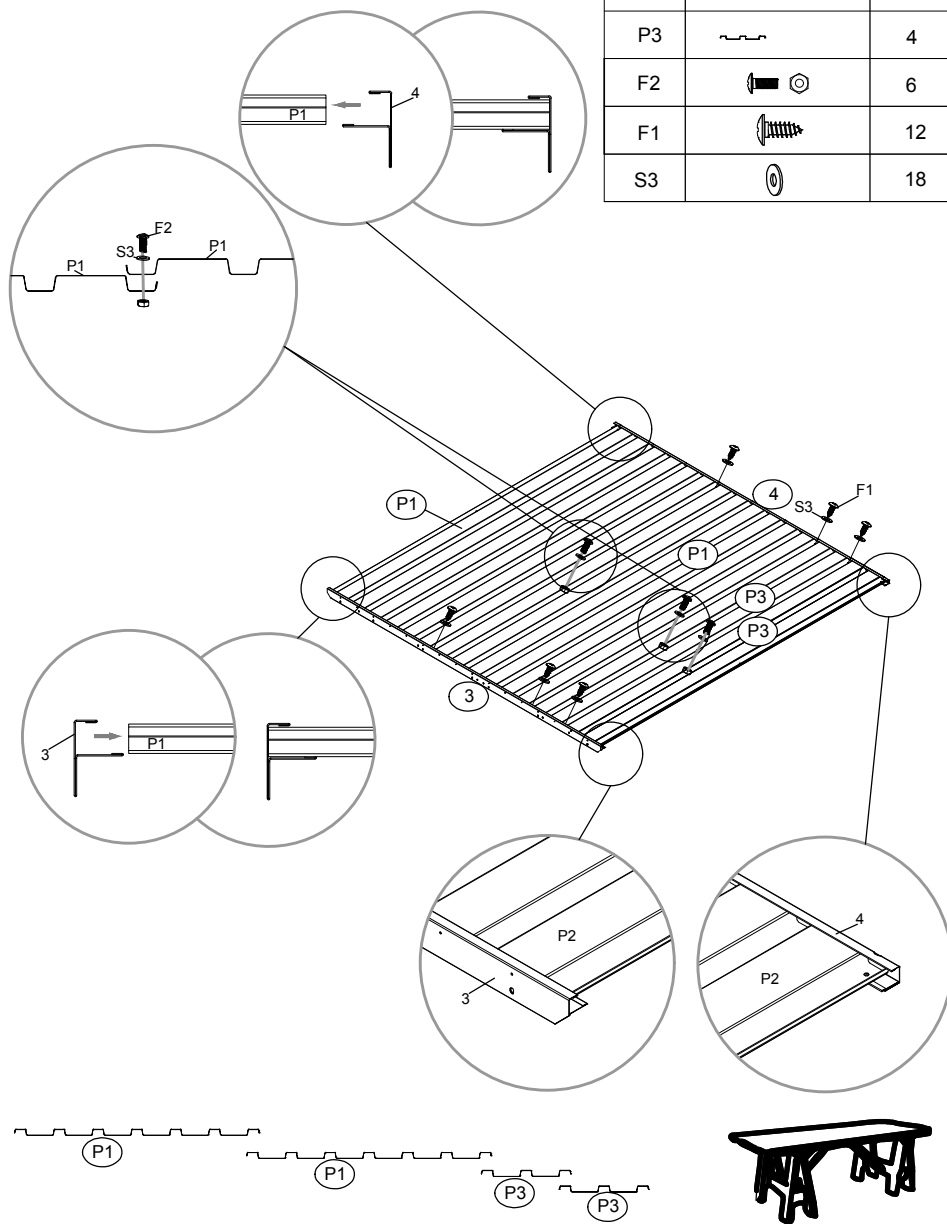







## PASO 2: PANEL TRASERO

ETAPA 2: PAINEL TRASEIRO

ÉTAPE 2: PANNEAU ARRIÈRE





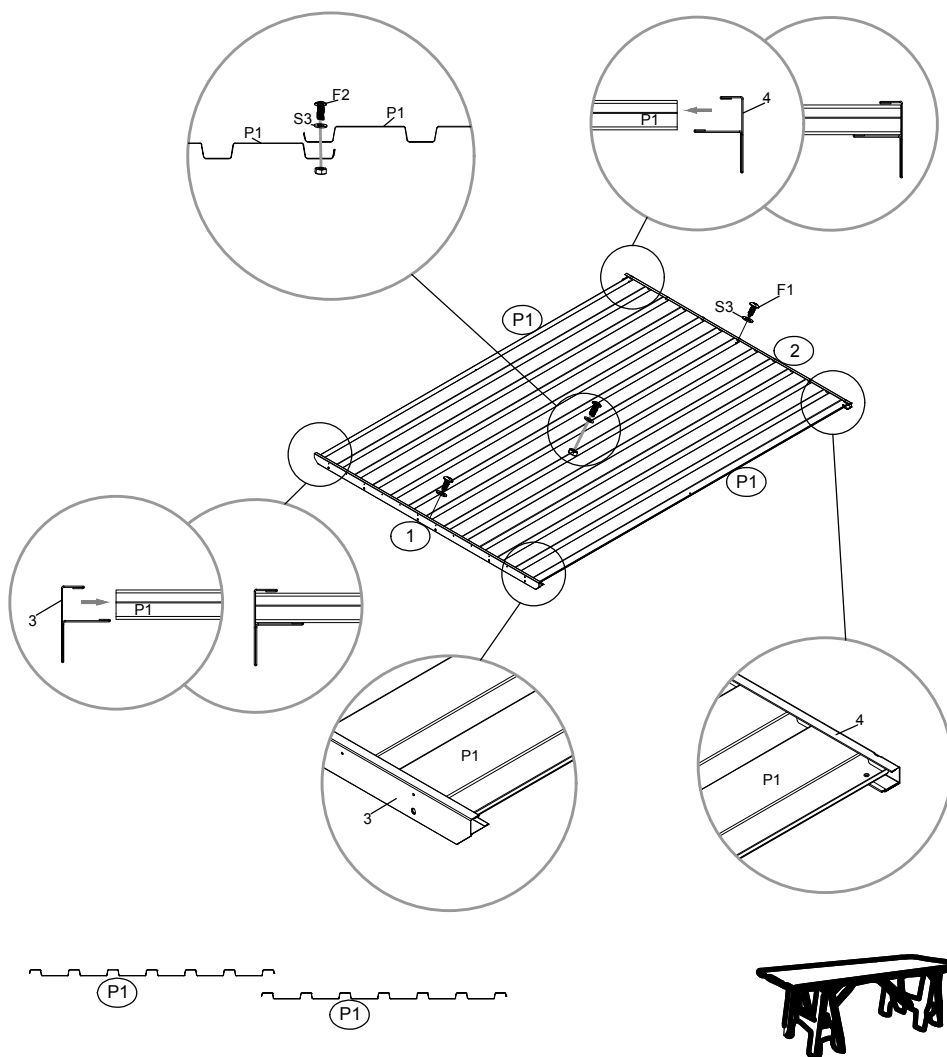



STEP 2: REAR WALL

NO.	PART	Qty.
1		1
2		1
P1		2
F2		1
F1		2
S3		3



### PASO 3: PANEL FRONTAL

ETAPA 3: PAINEL FRONTAL  
 ÉTAPE 3: PANNEAU AVANT  
 STEP 3: FRONT WALL

NO.	PART	Qty.
P3		2
5		1
6		1
7		1
8		1
F2		2
F1		4
S3		6

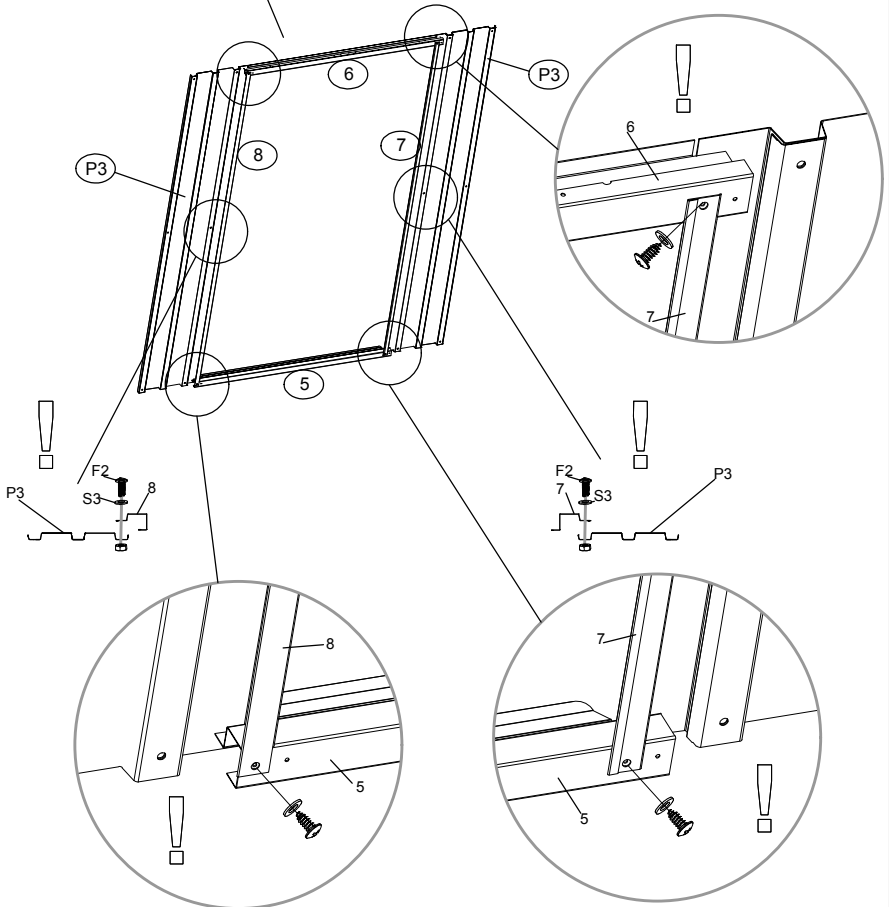
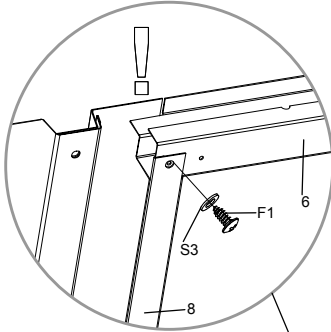





### PASO 3: PANEL FRONTAL

ETAPA 3: PAINEL FRONTAL

ÉTAPE 3: PANNEAU AVANT

STEP 3: FRONT WALL

NO.	PART	Qty.
1		1
2		1
F1		4
S3		4

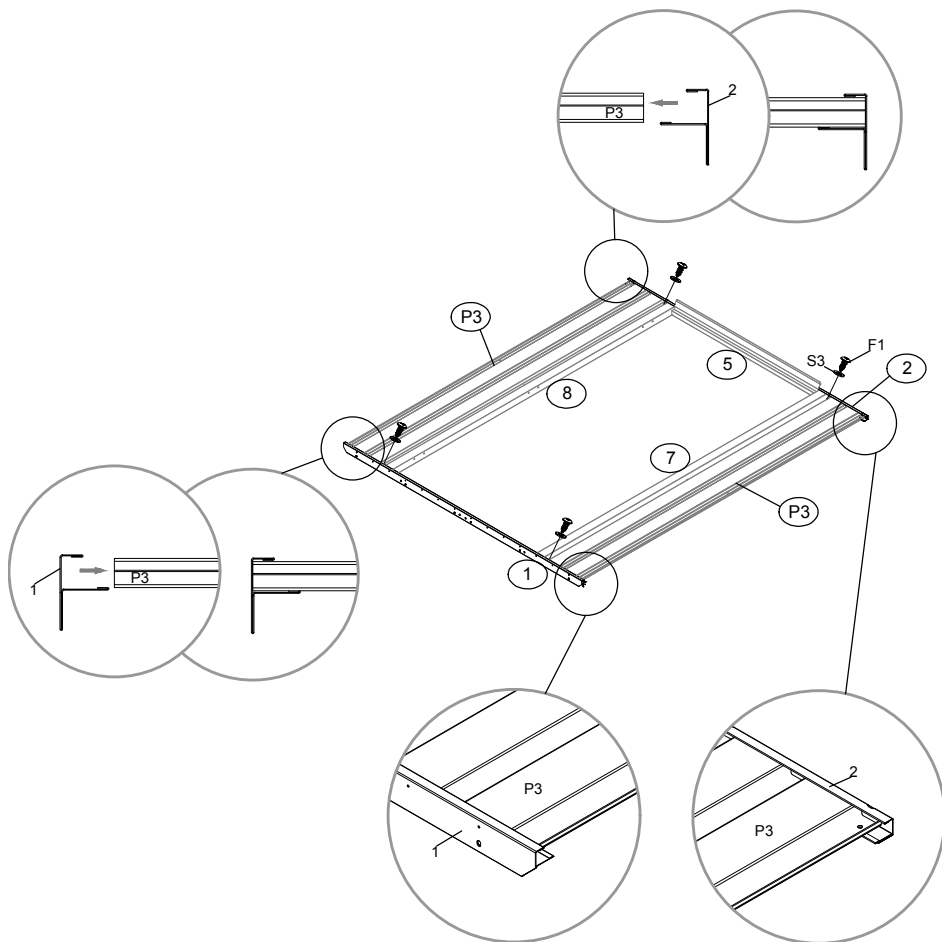





## PASO 4: MONTAJE DE LOS PANELES

ETAPA 4: MONTAGEM DOS PAINÉIS

ÉTAPE 4: MONTAGE DES PANNEAUX

STEP 4: WALL ASSEMBLY

NO.	PART	Qty.
L1		8
F1		16

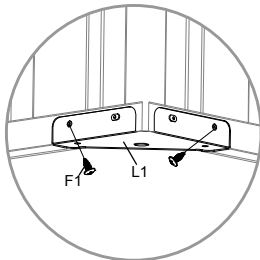
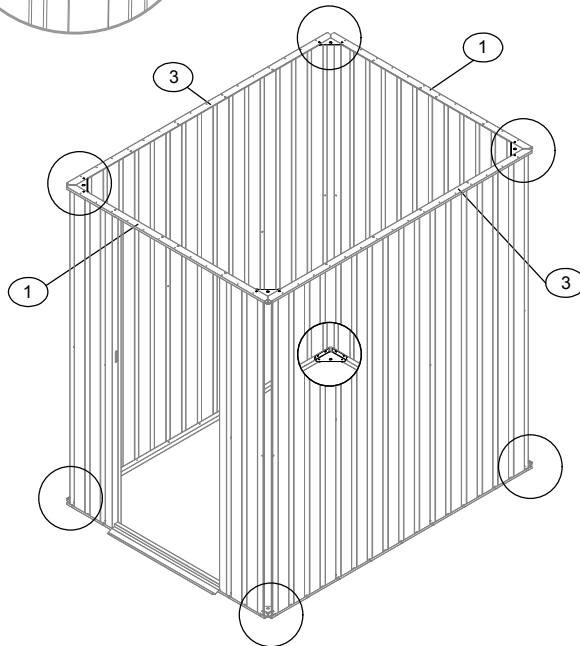
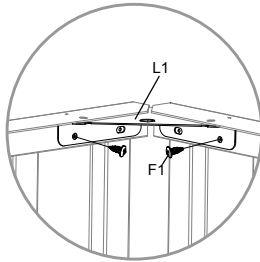





## PASO 4: MONTAJE DE LOS PANELES

ETAPA 4: MONTAGEM DOS PAINÉIS

ÉTAPE 4: MONTAGE DES PANNEAUX

STEP 4: WALL ASSEMBLY

NO.	PART	Qty.
16		4
S3		24
F1		16
F2		8

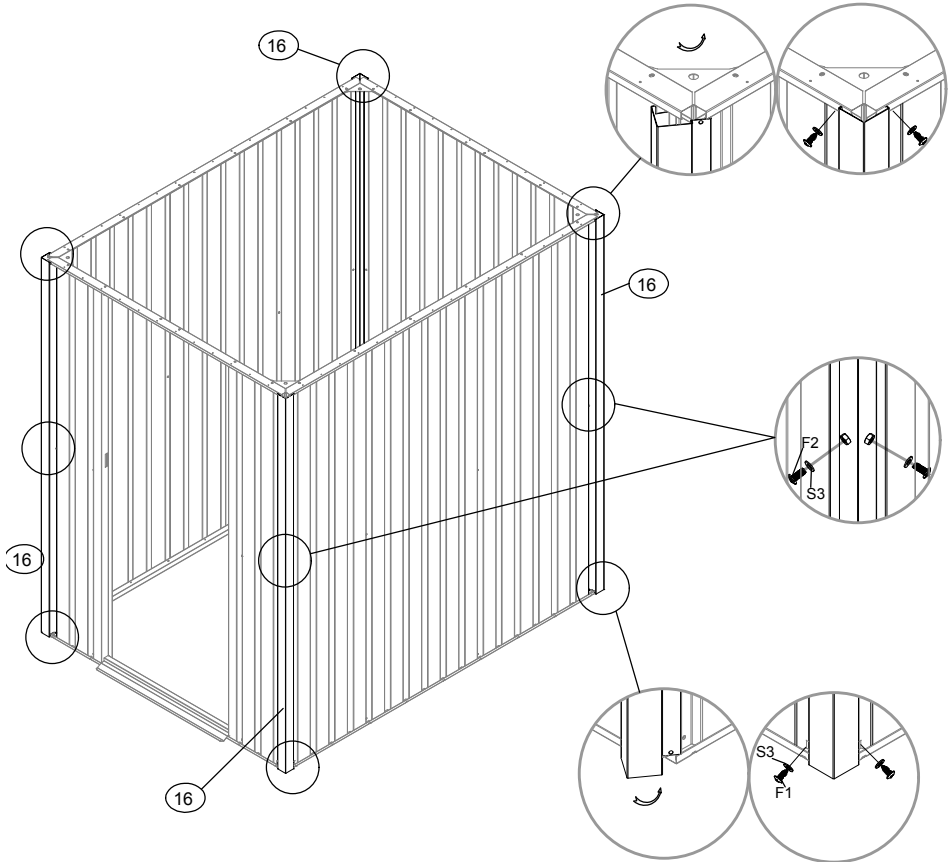









## PASO 5: MONTAJE DE LA FIJACIÓN DEL TECHO

ETAPA 5: MONTAGEM DA FIXAÇÃO DO TETO

ÉTAPE 5: MONTAGE DE LA FIXATION AU PLAFOND

STEP 5: GABLE & BEAM ASSY

NO.	PART	Qty.
21		2
20		2
13		2
14		2
18		1
F1		52
F2		4
S3		16

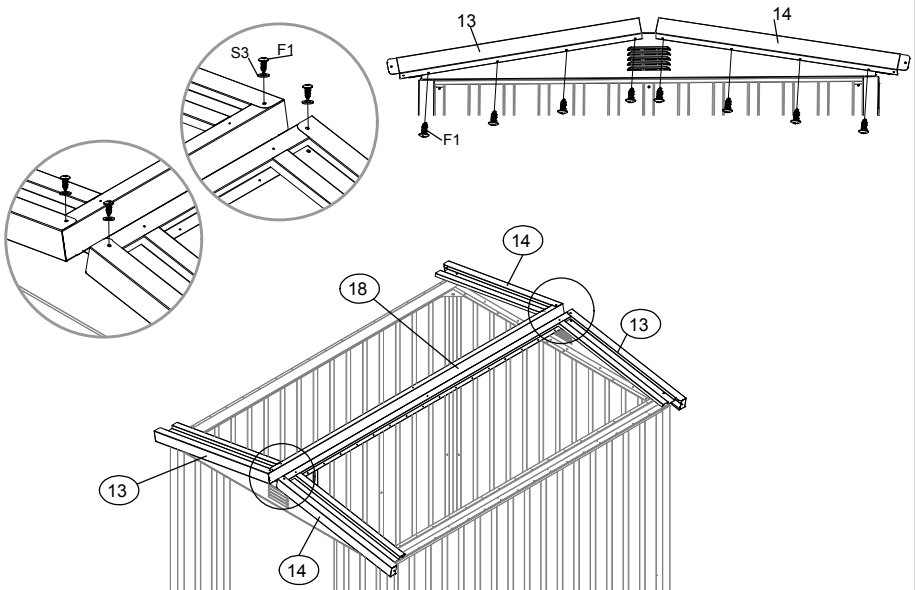
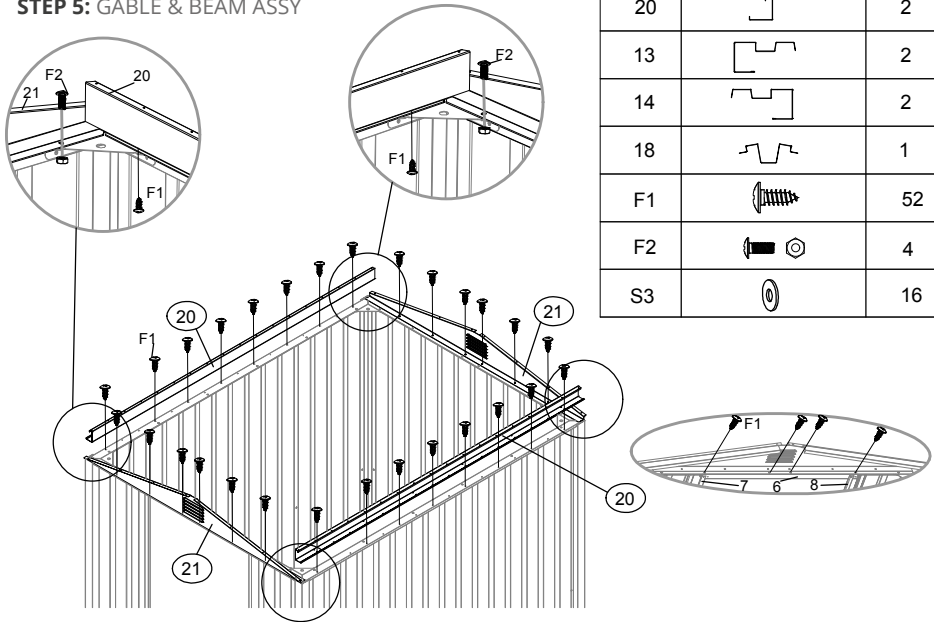







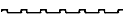

## PASO 6: MONTAJE DEL TECHO

ETAPA 6: MONTAGEM NO TETO

ÉTAPE 6: MONTAGE AU PLAFOND

STEP 6: ROOF INSTALLATION

NO.	PART	Qty.
P7		4
P9		4
12		2
GS		4
19		1
GE		2
S3		76
F1		80
F2		8

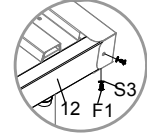
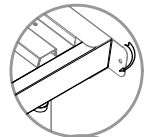
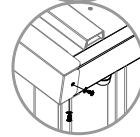
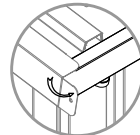
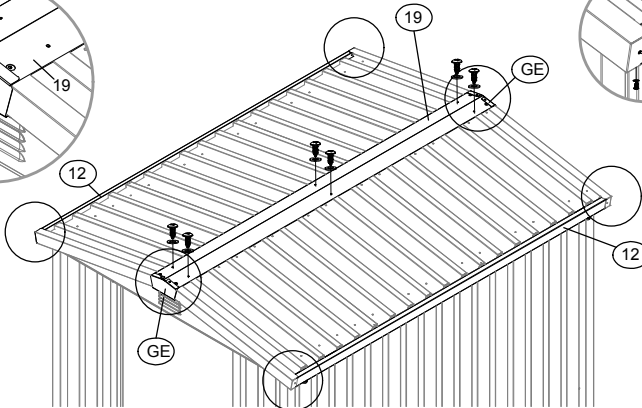
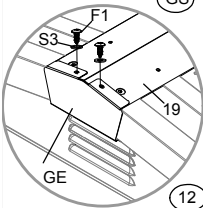
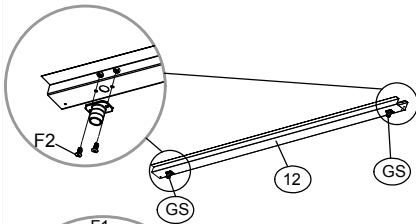
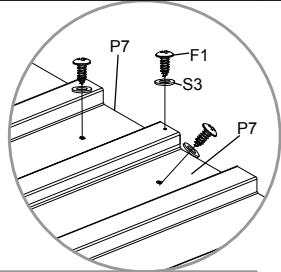
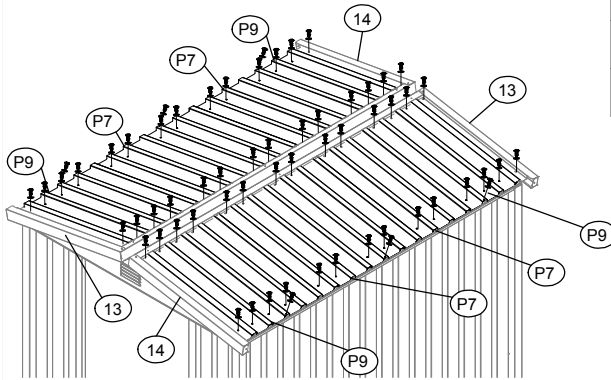
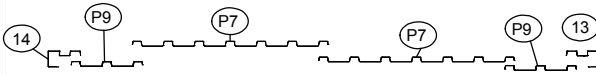



## PASO 7: MONTAJE DE LA PUERTA

ETAPA 7: MONTAGEM DA PORTA

ÉTAPE 7: ASSEMBLAGE DE LA PORTE

STEP 7: DOOR ASSEMBLY

NO.	PART	Qty.
D2		1
B6		2
F3		6

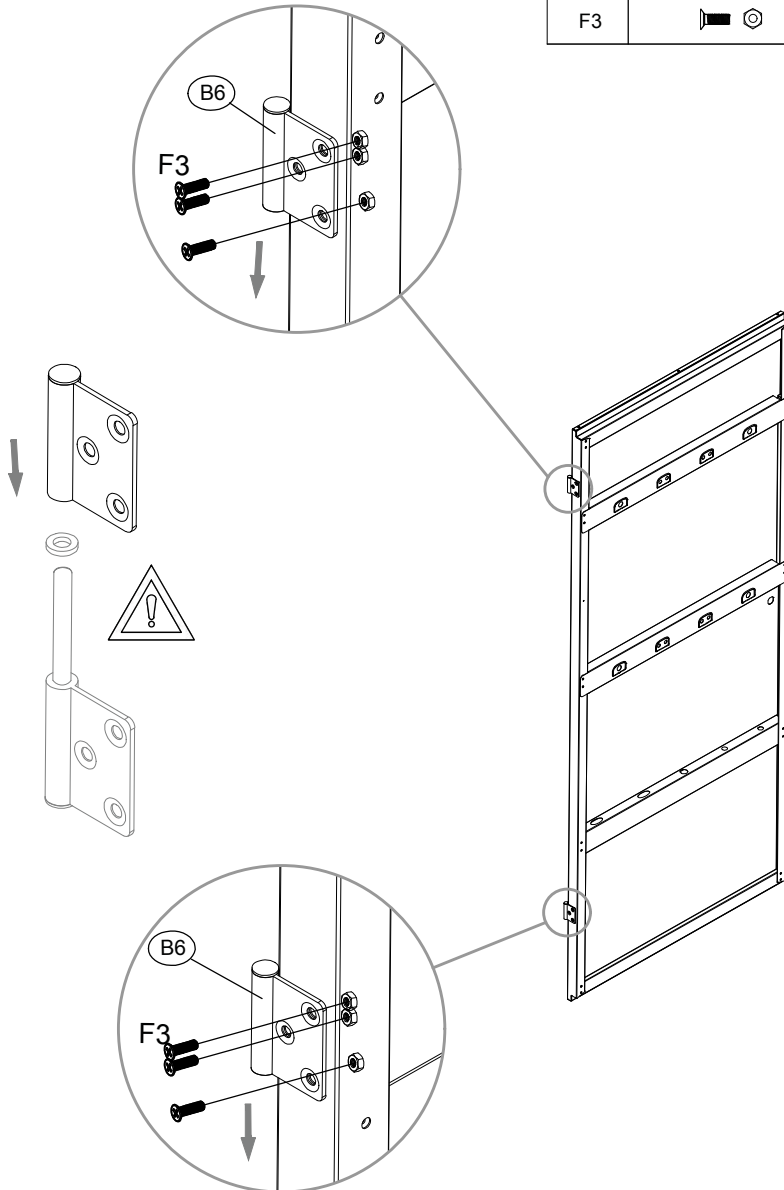



## PASO 8: INSTALACIÓN DE LA PUERTA Y CERRADURA

ETAPA 8: INSTALAÇÃO DA PORTA E DA FECHADURA

ÉTAPE 8: INSTALLATION DE LA PORTE ET DE LA SERRURE

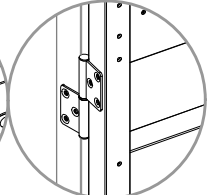
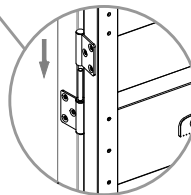
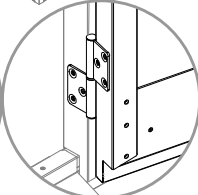
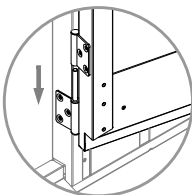
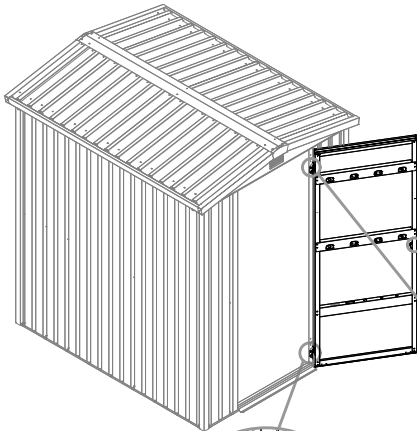
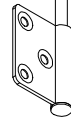
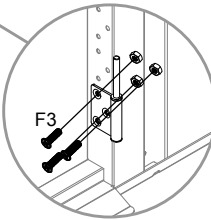
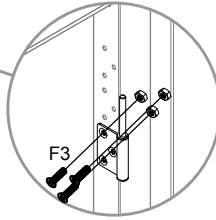
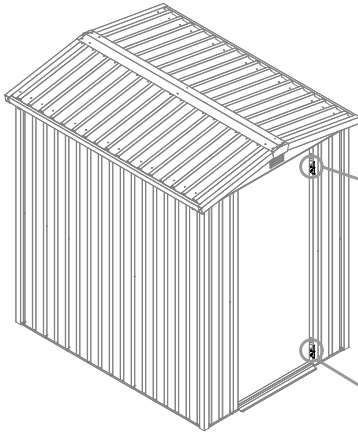

STEP 8: INSTALLING THE DOOR AND LOCK

NO.	PART	Qty.
B6		2
F3		6



## PASO 8: INSTALACIÓN DE LA PUERTA Y CERRADURA

ETAPA 8: INSTALAÇÃO DA PORTA E DA FECHADURA  
 ÉTAPE 8: INSTALLATION DE LA PORTE ET DE LA SERRURE  
 STEP 8: INSTALLING THE DOOR AND LOCK

NO.	PART	Qty.
K1		4
K3		2
GB		1

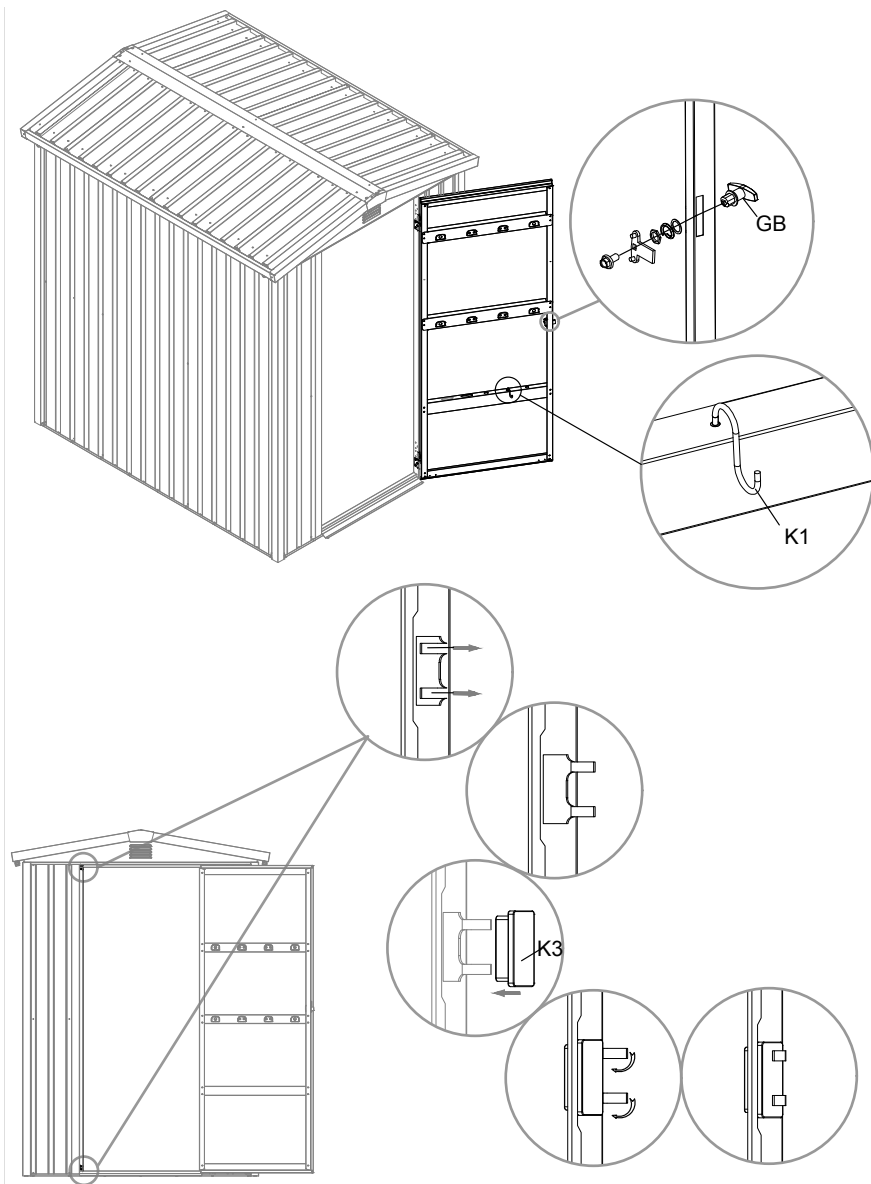



**FABRICADO E IMPORTADO POR:**

OKORU GLOBAL S.L.  
Polígono Industrial de Barros 29,  
39408, Barros, Cantabria, España.  
CIF: B-39856455

**PARA:**

LEROY MERLIN ESPAÑA S.L.U.  
Av. de la Vega, 2  
28108 Alcobendas, Madrid, España.

BCM BRICOLAGE, S.A.  
Rua Quinta do Paizinho nº10 - 12  
2790-237 Carnaxide.



MADE IN CHINA