

CAJONERA - 3 cajones / CHEST OF DRAWERS - 3 drawers / COMMODOE - 3 tiroirs / GAVETEIRO - 3 gavetas

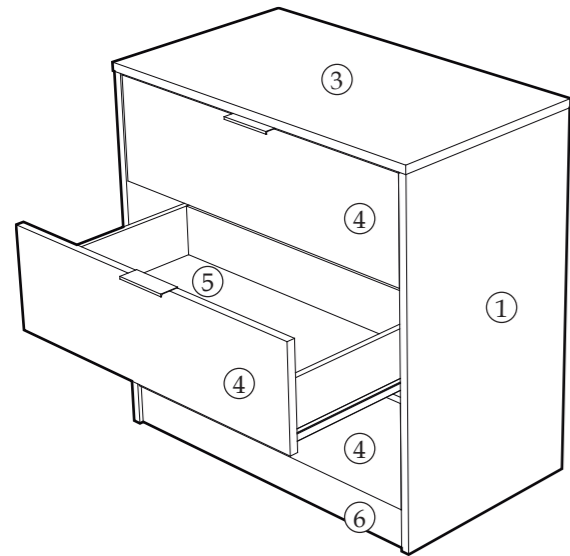

CARACTERÍSTICAS GENERALES / GENERAL CHARACTERISTICS / CARACTÉRISTIQUES GÉNÉRALES / CARACTERÍSTICAS GERAIS:

Referencia / Reference / Référence / Referência: K-657

Descripción: K-657 Cajonera 3 cajones / K-657 Chest of drawers - 3 drawers / K-657 Commode - 3 tiroirs / K-657 Gaveteiro - 3 gavetas

Alto / High / Haut / Altura: 703 mm
Ancho / Width / Large / Largura: 800 mm
Fondo / Depth / Profondeur / Profundidade: 400 mm

COMPOSICIÓN DE PIEZAS / COMPOSITION OF PARTS / COMPOSITION DES PIÈCES / COMPOSIÇÃO DE PEÇAS:

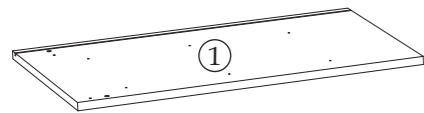

Costado derecho / Right side / Côté droit / Lado direito
689 x 398 x 16

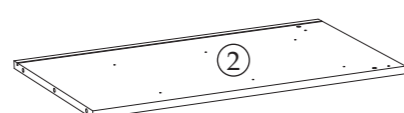

Costado izquierdo / Left side / Côté gauche / Lado esquerdo
689 x 398 x 16



Tapa / Top / Toit / Tampa
802 x 400 x 16

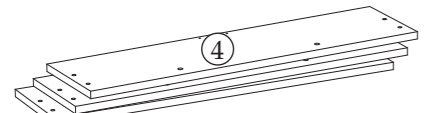

Frente de cajón / Front of drawer / Front du tiroir / Frente da gaveta
763 x 199 x 16

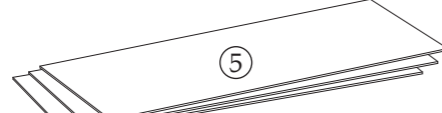

Fondo de cajón / Bottom of the drawer / Fond du tiroir / Fundo da gaveta
344 x 730 x 3

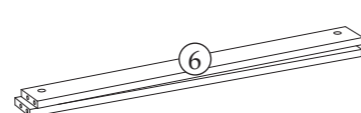

Barra / Bar / Barre / Barra
767 x 76 x 16

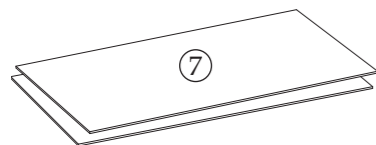

Trasera / Back panel / Arrière / Traseira
639 x 388 x 3

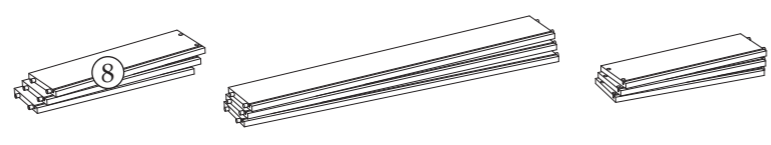

Cajón / Drawer / Tiroir / Gaveta

HERRAJES / FITTINGS / QUINCAILLERIE / FERRAGENS:

ESP30 10		CL 	DES 5 	EXC 4 	PER 4
SOPF 6 	TIR 3 	RM16 30 	BC 1 		
GEXT300 6					

ADVERTENCIAS MONTAJE / ASSEMBLY INFORMATION / AVISOS DE MONTAGEM:

Montaje del mueble sobre una superficie de protección.

Mount the furniture on a protective surface.

Montagem do móvel sobre uma superfície de proteção.

Material necesario para el montaje del mueble.

Material that you have to use for assembly.

Material utilizado na montagem do móvel.

Algunos pasos del montaje requieren de dos personas para su correcta realización.

Some assembly steps require two people.

Alguns etapas exigem 2 pessoas para para sua montagem.

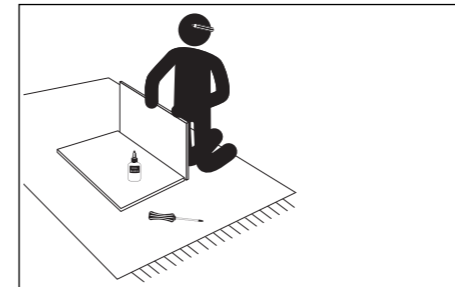

Este montaje debe realizarse por un montador cualificado, ya que un montaje incorrecto podrá dar como resultado la caída del mueble y causar daños a personas o cosas.

This assembly requires a qualified fitter. Incorrect installation can result in the furniture falling and possibly causing damages to property or persons.

A montagem deverá ser efectuada por uma pessoa qualificada, porque a montagem incorrecta pode provocar a queda do móvel e causar lesões a pessoas ou a coisas.

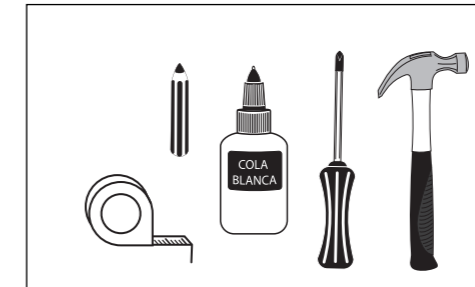

Como existen diferentes materiales de pared, no se incluyen los tornillos de montaje ni tacos que anclarán a esta parte.

All the necessary fittings to suspend the furniture is not included, since different wall materials require different types of fastening devices.

Pois existem diferentes materiais de parede, os parafusos e cavilhas de montagem que seguram esta parte não estão incluídos.

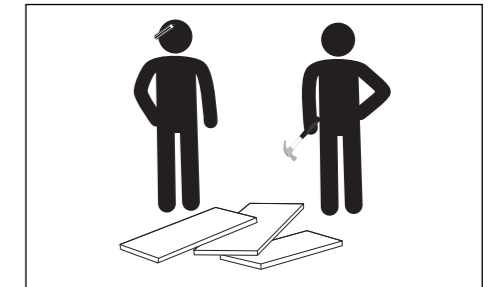

Para encontrar el sistema de sujeción adecuado a su pared póngase en contacto con su especialista mas cercano.

Contact your nearest specialist to find the right attachment system

Para encontrar parafusos adequados à sua parede, entre em contato com o profissional mais próximo.

MONTAJE / ASSEMBLY / ASSEMBLAGE / MONTAGEM:

